

CG-5

Scintrex Autograv System

OPERATION MANUAL

SCINTREX

Rev	Description of change	ECO	Date of issue	App
0	Initial Release		Aug. 03, 2006	R.L.
1	Additional Information	4414	Dec. 14, 2006	R.L.

CG-5 SCINTREX

Scintrex Autograv System

Operation Manual



CINTREX LIMITED

HEAD OFFICE

SCINTREX Limited
222 Snidercroft Road,
Unit #1
Concord, Ontario
Canada, L4K 2K1
tel: +1-905-669-2280
fax: +1-905-669-6403
e-mail:
service@scintrexltd.com

In the U.S.A.

Micro-g Lacoste
1401 Horizon Avenue
Lafayette, Colorado 80026
tel: +1-303-828-3499
fax: +1-512-828-3288
e-mail:
info@microglacoste.com

World-wide web: <http://www.scintrexltd.com>

Copyright © SCINTREX Limited 2006. All rights reserved.

No part of this publication may be reproduced, stored in a retrieval system or transmitted, in any form, or by any means, electronic, mechanical, photo-copying, recording, or otherwise, without prior consent from SCINTREX Limited.

Document Part No. 867700, Rev. 1

Printed and bound in Canada

Table of Contents

Table of Contents	2-v
Foreword	
Hardware Features	3-xiv
Software Features	3-xvi
Application Software	3-xviii
Options	3-xviii
Getting Started	
About this Manual.	1-1
Page Numbering	1-1
Type Styles	1-2
Chapter Layout	1-3
Symbols	1-4
Understanding Instrument Basics	1-5
Unpacking the Instrument	1-5
Removing the Instrument from its Case	1-6
Location of the CG-5 Sensor	1-7
Operating the CG-5 For the First Time	1-8
Powering up the Autograv	1-8
CG-5 Batteries	1-10
Using the Battery Charger	1-11
Cold Boot	1-11
Resetting the CG-5	1-12
Overview of the Console and Keypad	1-14
Navigating the Keyboard	1-15
Function keys	1-15
Function/Alphanumeric Keys	1-16
Direction/Sign Keys	1-17
Turning the CG-5 Display On	1-18
Adjusting the Contrast	1-18
Display Heater	1-19
Working with the Display and Menus	1-19
Moving Between Menus: Example 1	1-20
Moving Between Menus: Example 2	1-22
Moving Between Menus: Example 3	1-22
Entering and Editing Information	1-23
Switching Between Preset Values in Fields	1-23

Entering Alphanumerics, Example 1	1-24
Entering Alphanumerics, Example 2	1-26
Power Supply Status Icon	1-28
Powered by batteries	1-28
Charging Batteries	1-28
Powered by External Supply	1-28
Accessing On-line Help	1-29
On-line Help	1-29
Accessing System Information	1-30
Initializing Instrument Parameters	1-31
Checking Drift Corrections	1-31
Recalling and Plotting Data Onscreen	1-32
Showing Survey Parameters	1-32
Plotting Profile Line Data	1-33
Showing Numeric Line Data	1-34
Dumping Data	1-36

Setting Up Your Instrument

Accessing the Setup Screen	2-2
Using the Survey Screen	2-3
Specifying Header and Station Designation Information	2-3
Specifying the Survey Identifier	2-3
Specifying Optional Header Parameters	2-6
Specifying Grid Reference Point Parameters	2-7
Specifying a Station Designation System	2-8
Using the Autograv Screen	2-11
Specifying Corrections and Filters	2-11
To enable or disable a selection	2-12
Specifying Instrument Parameters	2-14
Saving Changes to Parameters	2-17
Cancelling Changes to Parameters	2-17
Using the Options Screen	2-18
Defining Reading and Cycling Options	2-18
Defining Reading Options	2-19
Using the Clock Screen	2-22
Automatic setting of time and date	2-23
Manual setting of time and date	2-23
Using the Dump Screen	2-25
Setting Up for Data Dumping via RS-232C	2-25
Setting the Baud Rate	2-25
Starting a Dump	2-27
Using the Memory Screen	2-28
Working with the Memory	2-28

Accessing the Memory Option	2-28
Exiting without Clearing Memory	2-29
Clearing Memory	2-29
Using the Service Screen	2-31
Accessing Service Options	2-31
Accessing the Service Screen	2-31
Service and support	2-32
Software Upgrade	2-34
User Calibration	2-34
Enable Factory Test	2-35

Operating the CG-5 in the Field

Initializing Field Parameters	3-2
Setting up Autograv Parameters	3-2
Setting Up Survey Parameters	3-2
Setting Up Survey Options	3-3
Working with Station Designation Systems	3-3
Editing XY Stations and Lines	3-4
Editing NSEW Stations and Lines	3-5
Editing LAT/LONG Stations and Lines	3-7
Editing UTM Stations and Lines	3-8
Setting Up the Tripod	3-10
Setting up the CG-5 on the Tripod	3-11
Applying Terrain Corrections	3-12
Entering Ground Density and Zones	3-13
Entering Ground Density	3-14
Entering B Zone Inclinations	3-15
Leveling the CG-5	3-16
Performing Data Acquisition	3-17
Taking a Reading - Graphics Screen	3-17
Reviewing Raw Data	3-19
Recording Data	3-20
Canceling Data	3-20
Taking a Reading - Numeric Screen	3-21
Reviewing Raw Data	3-22
Recording Data	3-23
Canceling Data	3-23
Starting the Next Measurement	3-24
Entering Notes	3-25
Recording Notes	3-25
Accessing the Notes Option	3-25
Recording Notes using a Pre-Defined List	3-26
Recording Notes Using Macros	3-29

Recording Manually Entered Notes	3-32
Recalling Data	3-33
Working with Stored Data	3-33
Recalling Stored Data	3-33
Scrolling Through Your Surveys	3-34
Plotting Line Data	3-36
Recalling Line Data	3-37
Dumping Data	3-38
Dumping Data using the RS-232C Port.	3-38
Connecting the RS-232C Cable.	3-39
Starting the SCTUTIL Program for RS-232 Data Dumping	3-39
column 1 Gravity	3-42
column 2 Tilt X	3-43
column 3 Tilt Y	3-43
column 4 Temperature	3-43
Setting Communication Parameters in the SCTUTIL Program	3-45
Setting Communication Parameters in the CG-5	3-47
Starting the CG-5 Dump Process.	3-48
Starting the SCTUTIL Dump Process	3-48
Converting Raw Data to SGD	3-51
Dumping Data Through a USB Port	3-52
Minimum System Requirements	3-52
Dumping Data with the USB Port.	3-53
Reprogramming your CG-5	3-57
Using the RS-232 Cable to Upgrade	3-60
Clearing Memory	3-63

Optimizing your Field Operations

Tips for Better Results	4-2
Transporting and Handling	4-2
Minimizing Motion Noise	4-3
Minimizing Wind Noise	4-4
Selecting Base Stations.	4-5
Operating in Cold Weather	4-5
Using the CG-5 Before Warm-Up Stabilization is Complete	4-5

Maintaining Your CG-5 and Trouble-shooting

Using the Battery and Power Adapter.	5-1
Powering the Instrument	5-2
Using the Smart Battery	5-2
Understanding Temperature Effects	5-3
Monitoring Voltage.	5-4

Understanding Life Expectancy	5-4
Replacing a Battery.	5-5
Changing or Inserting a Battery	5-5
Using the Power Adapter	5-6
Estimating Charging Time.	5-6
Charging Notes	5-7
Using the external battery belt	5-8
Adjusting Instrument Parameters	5-10
Applying Drift Corrections	5-10
Obtaining Accurate Results.	5-11
Automated Drift Adjustment Software	5-11
Enabling the Drift Constant Routine	5-11
Adjusting Drift Manually	5-13
Measuring Drift	5-13
Reading the Data	5-14
Adjusting the Drift Correction.	5-15
Applying Tilt Corrections.	5-17
Adjusting Tilt Sensor Offsets (TiltX.Offs and TiltY.Offs)	5-17
Performing TiltX.Offs Adjustment	5-17
Performing TiltY. Offs Adjustment	5-24
Adjusting Tilt Sensor Sensitivity (TILT XS, TILTYS)	5-25
Adjusting X-axis Sensitivity	5-25
Adjusting Y-axis Sensitivity	5-28
Adjusting Tilt Sensor Cross- Coupling.	5-29
Measuring Cross-Coupling	5-29
Adjusting Cross-Coupling	5-30
Re-Calibrating the CG-5.	5-32
Other Helpful Hints	5-34
Maintaining the Tripod.	5-34
Storing the Autograv	5-34
Trouble-shooting	5-35
Trouble-shooting your USB port.	5-37
Incompatible operating system	5-37
Prevent power loss from the USB port	5-37
CG5 devise or computer hardware issue	5-38
Cable disconnected, loose or defective	5-38
Faulty USB connect on computer	5-38
Incorrect USB or devise setup in Windows.	5-38
Checking USB and CG5 status in Devise Manager	5-39
USB port incorrectly configured in BIOS.	5-39
USB Controller or root hub disabled in Windows Device Manager.	5-40

USB controller IRQ conflict	5-41
CG5 driver installed incorrectly	5-41
USB chipset issue	5-42
Removing USB entries from the Windows Device Manager	5-43
To start Windows in SAFE MODE	5-43
Removing USB completely	5-44
Windows XP USB 2.0 driver not installed	5-45
Warranty and Repair	5-46
Warranty	5-46
Repair	5-46
Shipping Instructions	5-47

Reference Information

General Specifications	6-2
Hardware Specifications	6-3
Software Specifications	6-4
Software Specifications	6-6
Standard Accessories	6-7
Optional Accessories	6-7
Application Software	6-8
Training	6-8
Instrument Parts List	6-9
CG-5 Meter and Standard Accessories	6-9
Options	6-10

Appendix A: Remote Operation of the CG-5

Setting Up for Remote Operation	A-1
Enabling the remote password	A-1
Installing the CG5 Remote Software	A-4
Starting CG5REMOTE and Linking to the Autograv	A-10
Configuring Survey Settings	A-11
Configuring Autograv Settings	A-12
Configuring Options	A-14
Setting the CG-5 Clock	A-16
Measuring Data	A-17
Leveling the Instrument	A-17
Recording Data	A-18
Generating Output	A-19
Dumping Data	A-21
Erasing Memory	A-22
Disconnecting	A-23



Appendix B: Theory of Operation

System Overview	B-1
Control Console and Software	B-4
Spring Service Life and Reading Range	B-6
Processing of the Gravity Signal	B-9
Seismic Filter	B-11
Compensation and Corrections	B-16
Drift Correction	B-16
Tilt Correction (TIC)	B-17
Temperature Compensation (TEC)	B-19
Earth Tide Correction (ETC)	B-20
Residuals	B-20
Gravity Offset (GREF)	B-21

Appendix C: Elastic Hysteresis Effects

Appendix D: Scintrex Utilities Program

Installing SCTUTIL	D-2
Installing your USB driver	D-9

Appendix E: CG-5 Menu Maps

Setup Menu Maps	E-3
Survey Menu	E-3
Autograv Menu	E-3
Options Menu	E-4
Clock and Memory Menus	E-4
Dump and Service Menus	E-5
Measurement Menu Maps	E-6
Main Measurement Process Flow	E-6
Tilt Sensitivity Corrections	E-7
Other Menu Maps	E-8
Recall Menu	E-8
Display Menu	E-8
Info Menu	E-9
Note Menu	E-9

Foreword

Congratulations on purchasing the CG-5 Autograv system from Scintrex Limited! You are in possession of one of the most versatile and advanced gravity systems for mineral exploration, oil and gas exploration, microgravity applications.



The Autograv Gravity Meter

The Autograv is a microprocessor-based automated gravity meter that has a measurement range of over 8000 mGals without resetting and a reading resolution of 0.001 mGal. This enables the Autograv to be used for both detailed field investigations and large scale regional or geodetic surveys.

Accurate measurements are taken by simply pressing a key and under most conditions it takes under one minute to complete the reading. A series of readings of gravity measurements can be performed by setting the Autograv in the cycling mode. The Autograv obtains a reading by continuously

averaging a series of 6 HZ samples. The individual readings are displayed directly in mGals. The data is stored in Flash memory and can be sent to a printer, modem, recorder or PC.

The gravity sensor, control system and battery are integrated into a single instrument housing, which doubles as a carrying case. This eliminates the need for packing and unpacking the sensor between readings. Stability is increased and the risk of an accident is reduced by the absence of an external cable between the battery and sensor. The mounting system which indexes the Autograv onto the tripod further increases instrument stability.

When setting the Autograv up for a reading, the software-based tilt sensors provide greater accuracy and are easier to operate than the conventional bubble levels. The gravity meter displays the outputs from the sensors on high resolution meters on the ¼ VGA display.

Excellent protection from changes in ambient temperature and atmospheric pressure is achieved by sealing the Autograv sensing element in a temperature stabilized vacuum chamber. The wide operating temperature enables the operator to use the Autograv in many environments. Since the sensor is made from non-magnetic fused quartz, the Autograv is not affected by magnetic field variations (as long as they are less than ten times the Earth's magnetic field, i.e. $\pm 0.5\text{mT}$).

Low drift is a result of the extremely stable operating environment of the quartz elastic system. It allows the long term drift of the sensor to be accurately predicted and a real time software correction reduces it to less than 0.02 mGals per day.

The internal Smart rechargeable battery provides sufficient power to operate the Autograv throughout a normal survey day. An operator can check the battery voltage at any time by pressing any key and viewing the display.

Hardware Features

The hardware components of the CG-5 comprise a graphic display, keyboard, data dump connectors, Flash memory, real time clock and a Smart battery supply.

Graphic Display and Keyboard

The graphic display is a quarter VGA display that operates at -20°C to $+45^{\circ}\text{C}$. When heated, the display operates from -45°C to $+45^{\circ}\text{C}$. Data entry is via a sealed 27 key alphanumeric keyboard.

Data Dump Connectors

The system is equipped with 2 COM (RS-232) ports for data transfer/dump and GPS support and operate between 600 to 57600 baud. It also has a USB port that operates at 12 MBits/sec.

Memory

The data storage memory is based on Flash technology with a standard configuration of 12 Mbytes which stores approximately 200000 readings. These values will vary depending on whether the user has enabled raw data acquisition which configures the system to digitize samples 6x every second. If the raw data acquisition mode is enabled, the actual memory capacity depends on the Read time duration selected by the user.

Real Time Clock

The real time clock is powered by a continuous Lithium battery backup.

Smart Battery Supply

The CG-5 is based on a Smart Battery configuration with dual batteries that are a standard Lithium camcorder type. The capacity is 6.6 Ah and the system provides for automatic switching from one battery to another as the capacity declines in the field.

GPS Receiver

The CG-5 comes with a GPS receiver (connected into the COM2 port) that allows the user to read the grid reference point for station co-ordinate and also sets RTC to the UTC.



Important:

The GPS receiver is non-differential and should not be used for accurate elevation readings.

Software Features

The software is based on a Scintrex proprietary operating system that provides a GUI (Graphic User Interface) windows style interface and many additional features. The system is upgradeable in the field using both RS-232 and USB connections.

Automated Data Corrections

Corrections provided in the system include Tide, Instrument Tilt, Temperature, advanced Noisy Reading Rejection, Seismic Noise Filter / FIR Filter and Near Terrain Corrections.

Self Diagnostic

To protect the data, the CG-5 verifies data integrity on power up and maintains the status of all calibration parameters set by the user and the integrity of the data base.

User Calibration

For maintenance purposes, the system provides an easy-to-use graphic interface for entering and updating calibrations. Computations are performed automatically, for Tilt offsets, for example, eliminating the user need to calculate parameters manually as in previous systems. The CG-5 also automatically stores variables related to calibrations.

Reading Data Presentation

Data is presented in a digitized Signal Graphic format that resembles an oscilloscope display, and also provides a numeric, single screen that enables easy viewing of all parameters. Leveling information is presented via a graphic cross-hair format that simplifies the leveling process.

Data Recall

Data recall can be either on a graphic line profile basis or accomplished through numeric individual reading of parameters.

Data Dump

For versatility, the CG-5 provides two methods of dumping data (i.e. RS-232 and very fast USB) in a binary data image format. Post processed (i.e. output) data can be obtained in a variety of formats, including:

- *.SGD (Scintrex proprietary format)
- *.TXT (full ASCII headers and data)
- *.XYZ (ASCII data only spreadsheet)
- *.SMP (Raw sample values)

Data Storage

Data can be stored either as individual readings or raw samples (digitized at 6x per second for post-processing). Note and calibration information is also stored in the system.

Station Designation System

Multiple station designation systems are supported including:

- NSEWm (Line 100N, Station 20S)
- NSEWft (Line 100N, Station 20S)
- XYm (Line 100, Station -20)
- XYft (Line 100, Station -20)
- UTM (Easting 548906E, Northing 5432145S)
- LAT/LONG (Longitude 49E 50' 34", Latitude 12N, 13', 22")

Near Terrain Corrections

The system enables entry of Hammer chart-type data in a graphic format and automatically corrects data for elevation and density.

Remote Control

For users who wish to install and monitor gravity readings remotely, the system can be operated in this mode. This is not for full monitoring purposes.

Smart Battery Status

The CG-5 monitors the Smart Batteries and their capacity level to provide the operator with an actual report of time left in hours so that batteries can be replaced as required in the field.

Application Software

Scintrex provides two proprietary programs to assist in operating the CG-5.

SCTUTIL

SCTUTIL is a windows-based GUI type program that controls data dumping via RS-232 and USB ports. It also processes and outputs data in any of the formats reported previously. SCTUTIL also enables uploading of operating system upgrades as they are released. It comes fully equipped with USB drivers to enable users to configure their Personal Computers for fast, reliable data dumping.

CG5REMOTE

CG5REMOTE is a windows-based GUI type program that controls remote operation of the system as well as all system parameters.



Important:

The remote feature does not provide a remote monitoring capability to the CG-5.

Options

A remote start device, based on Radio Frequency technology is available as an option. This allows the user to control the CG-5 at an unobstructed distance of up to 20 m.



Getting Started

About this Manual

Page Numbering

The numbering scheme used consists of two parts: the *chapter number* and *page number*. For example, **3-1** would refer to chapter **3**, page **1**.

For your convenience, each chapter has a thumb-tab on the right-hand side allowing you to quickly locate a chapter of interest. The thumb-tabs are arranged in descending order, with Chapter 1 always starting at the top.

Type Styles

The following typeface conventions will be used throughout the manual.

Convention	Use
<i>Bold Italic</i>	Indicates an action to be taken
<i>Italic</i>	Denotes a new term being introduced
ALL CAPS	Denotes the name of a screen, key or mode (function)





Chapter Layout

This manual is divided into six chapters and four appendices with the information flow detailed in the following table.

Chapter	Description
1. Getting Started	Gives an overview of the manual and walks you through the instrument's components, and basic menus and keypad.
2. Setup	Tells how to set up your CG-5 for a gravity survey, including how to set standard instrument survey parameters.
3. Operations	Describes each step in a gravity survey. It includes a description of how to start the meter, level the meter, apply terrain corrections, record data, review results, and dump data.
4. Optimizing	Describes the necessary steps to optimize your gravity survey to obtain the best quality data.
5. Maintenance	Reviews basic maintenance, corrections and trouble-shooting.
6. Reference	Contains the technical specifications, instrument parts list and warranty information.
A. Utilities Program	Details the procedures on how to install the SCTUTIL utilities program, how to upgrade the software version and install the USB driver.
B. Remote	Reviews the remote operation of the CG-5.
C. Theory of Operation	Explains the scientific and instrumentation theory for the gravity method and CG-5 instrument.
D. Hysteresis Effects	Provides a brief description of how hysteresis effects are minimized in the CG-5.
E. CG-5 Menu Maps	Shows flowcharts of major setup, functional and measurement menus in the system.

Symbols

The following symbols will be used to highlight specific sections of text throughout the manual.

Symbol	Meaning
	Warning: Denotes an important point concerning safety
	Important: Indicates a important topic, particular attention should be paid to this section
	Note: Denotes a point of interest, or information you should read
	Tip: Denotes an interesting hint for smoother operation
	Question: Indicates a relevant question concerning an important topic

Understanding Instrument Basics

This chapter gives an overview of the basic components, interfaces and procedures that you should become familiar with prior to making gravity measurements with your CG-5.

Unpacking the Instrument

The Autograv is packed in a padded case (with the battery disconnected to comply with transport safety regulations) in order to protect the instrument during shipment.

Startup

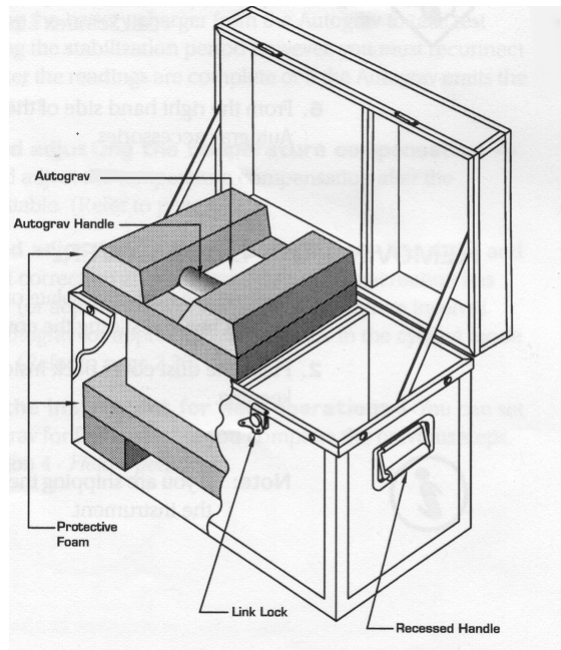

Figure 1-1 - Gravity Meter in Shipping Case



Important:

During shipment, the battery must be disconnected. If you have just received your CG-5, the battery is fully charged but disconnected. For information on

re-connecting the battery, please see Chapter 4, “Using the Battery and Power Adapter” and the “Replacing a Battery” topic on page 4-5.

Removing the Instrument from its Case

- a. Pull up the tab of the link lock and turn the tab *counter-clockwise* to unfasten the lock from the keeper plate.
- b. Repeat step a. for the other link lock.
- c. Open the Autograv transportation case by lifting the cover.
- d. Remove the protective foam from the left hand side of the transportation case to view the top of the Autograv.
- e. Remove the Autograv from its transportation case and visually inspect for any damage that may have occurred during transportation.
- f. From the right hand of the case, remove the Autograv accessories.



Important:

If there is any evidence of physical damage, immediately call Scintrex Limited. The CG-5 shipping case is equipped with a shockwatch monitor. This monitor is affixed to the side of the shipping box. Should you notice that the vial is red please contact Scintrex Limited immediately.



Location of the CG-5 Sensor

Startup

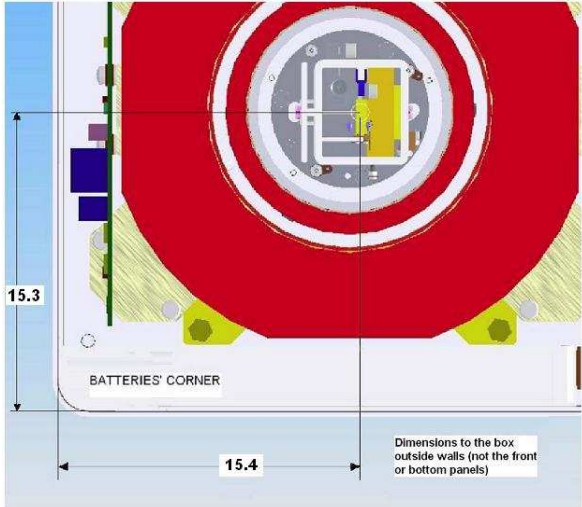
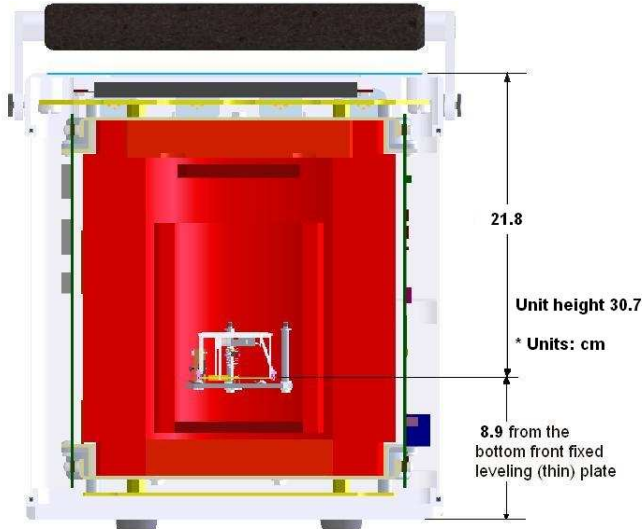

Operating the CG-5 For the First Time

When starting up the Autograv for the first time, or after it has been turned off for 48 hours, you must observe the following waiting periods.

- 1. Powering up the Autograv** - Use the charger to power up the instrument as well as the battery.
- 2. Warm-up period** - After you connect the battery charger to the Autograv, it requires a 4-hour warm-up time to reach its operating temperature.
- 3. Stabilization period** - After you connect the battery, you should allow a full 48 hours for instrument stabilization and warm up of the sensor. If this is your first use of the instrument, this is a good time to become familiar with the keypad and software. We suggest that you try initializing the software by resetting the time and date, erasing the memory and setting up the Autograv instrument parameters.
- 4. Checking and adjusting the drift correction** - This process involves running the Autograv for approximately 24 hours in the base station or auto-repeat mode.
- 5. Setting up the instrument for field operations** - After completing the previous steps, you are ready to set up your Autograv for field use. For more information, see Chapter 2, “Setting Up Your Instrument” and Chapter 3, “Operating the CG-5 in the Field”.

Powering up the Autograv

The CG-5 can be powered either by:

- The 15V DC external power supply
- One or both of the two internal Smart Batteries supplied with the CG-5

If the batteries are in place when the external supply is connected, the supply will power the unit and also charge the batteries if necessary. When the batteries are fully charged the supply powers the unit so that the batteries maintain their full charge. The batteries are charged sequentially and take approximately 4 hours each to charge.

The instrument is also supplied with a free standing battery charger which allows the batteries to be charged off-line.



Note:

Only use the power supply provided with the instrument - the use of another power supply could damage the instrument.

To power up the unit:

- **connect** the input of the external power supply to the mains (100 - 240V AC, 47 - 63 Hz)
- **connect** the 15V DC output to the two pin power socket at the rear of the CG-5 front panel

The unit will now power up whether or not batteries are installed.



Note:

The external power supply is cooled by a fan through vents on its top surface. To allow for adequate cooling always operate the power supply on a clear flat surface with nothing on top of it.

To insert a battery:

- **remove** the batteries compartment covers from the side of the unit
- If you look into the compartment you will see the connector on the bottom of the rear panel of the compartment. **Insert** the battery with the socket down so that it mates with the plug
- **Replace** the battery compartment cover.



Note:

You will know if you insert the battery the wrong way because the battery compartment cover will not close completely.



Note:The state of charge of the batteries is given by the small icon at the bottom of the screen or by the pressing the INFO key and displaying the information page as described later in this section.

When a battery is outside of the gravity meter its capacity can be observed on its own "Fuel Gauge".

CG-5 Batteries

The CG-5 uses rechargeable Lithium Ion "Smart Batteries". Each battery has internal sensors and a microcontroller which communicates with the battery charger to optimize the charging cycle. These batteries have the following specifications:

- Operating temperature range: -20 - +60 degrees C
- Storage temperature range: -20 - +60 degrees C. For long periods it is recommended to store below 25 degrees C
- Charging temperature: 0 - 45 degrees C
- Nominal voltage: 11.1V
- Nominal Capacity 6.6Ah

With two fully charged batteries the CG-5 will operate for longer than 14 hours at 25 degrees C without the need for recharging. As the operating temperature drops the battery capacity is reduced. At temperatures below -20 degrees C it is recommended that the optional battery belt be used.

When the batteries are discharged to below 10% of the total capacity a beeper will sound at 15 second intervals. At this point at least one charged battery should be installed in the CG-5 or the external supply should be connected. If this cannot be done the batteries should be removed to prevent them from being completely discharged. See the warning below.



Important: Do not completely discharge batteries when doing field work or storing the instrument. Completely discharging the battery can cause its calibration to be lost. In this case the battery will not report its status correctly resulting in a sub optimal charging cycle and reduced capacity. If this occurs recalibrate the battery using the battery charger supplied with the CG-5 as described in the troubleshooting guide.

Using the Battery Charger

The SBS 3002 battery charger can charge one or two batteries off line:

- Plug the power supply into the mains (100 - 240 VAC, 50 - 60 Hz)
- Plug the power supply output into the charger
- Insert one or two batteries into the bays

The batteries are charged sequentially and take approximately 4 hours each to charge.

The indicator lights on the front of the charger have the following meaning:

- Green blinking: Charging
- Green steady on: Charge complete
- Yellow steady on: Standby
- Red blinking - faulty battery

The left bay of the charger has a recalibration mode - this should be used as described in the troubleshooting section when capacity is reduced through loss of calibration.

Batteries can be charged over the temperature range of 0 - 45 degrees C.

Cold Boot

Once you have unpacked your CG-5, you should perform a cold boot to reset the instrument. This need only be done once in the lifetime of the instrument. On very rare occasions, you may find it necessary to carry out a cold boot (and only upon specific instructions from our customer service department).



Important:

Your data will be erased after you performed a cold. Should you have usable data in your CG-5, **dump** your data in the USB mode before performing a cold boot. Please refer to “Dumping Data with the USB Port” on page 3-53.

PRESS



To perform a cold boot, do the following:

Press and *hold* the SETUP/4/JKL key.

AND

and

PRESS



press the ON / OFF key to Power up. The unit will then prompt you with the following message:

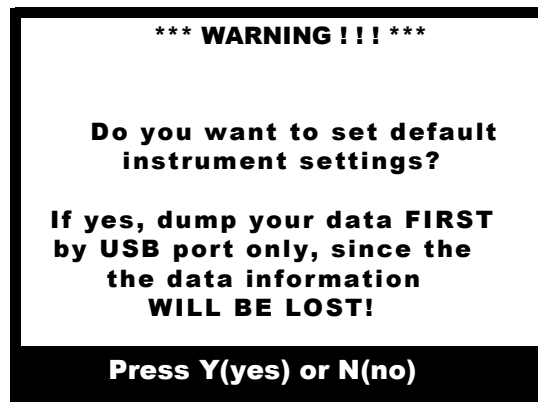

OR



Press the 9/YZ key to perform a cold boot

OR

Press the RECALL/5/MNO key to cancel.

Resetting the CG-5

On rare occasions, you may find that the display locks (i.e. you cannot move to another screen or access any of the functions).

To correct this situation, do the following:

PRESS



Press the F1 key.

AND

and

PRESS



ON / OFF keys together. The unit will then reset itself. Hold the setup key and all data will be erased.

Startup

Overview of the Console and Keypad

The following picture shows the front panel of the instrument. It comprises a display for viewing menus and results; keypad for entering parameters and recording data.

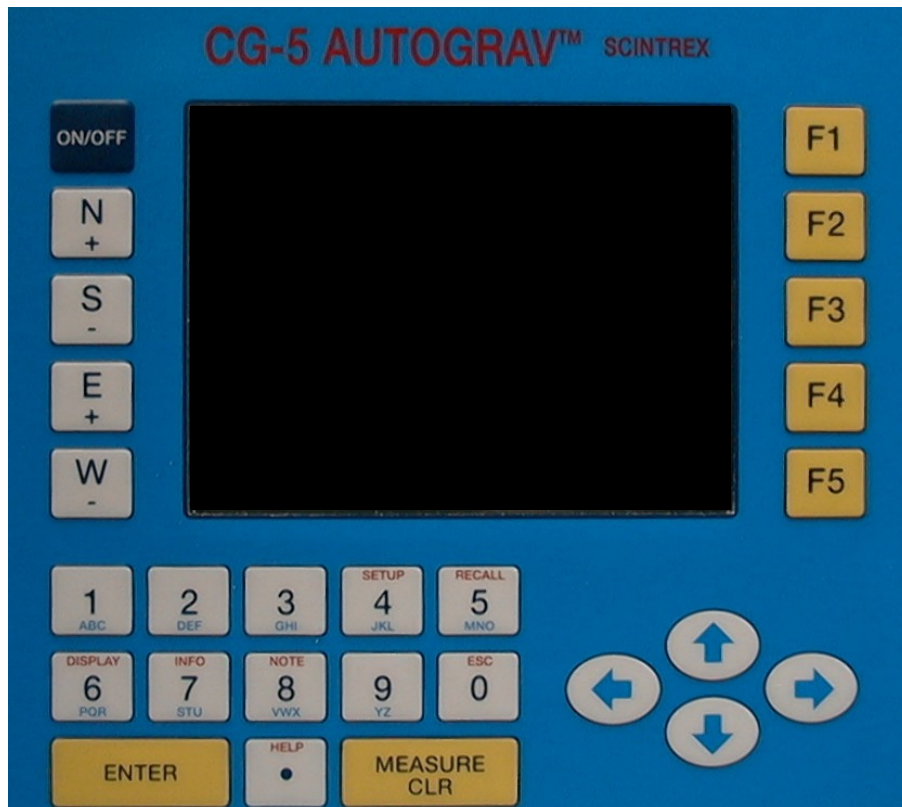

Figure 1-2 - Close Up of the CG-5 Console and Keypad

Navigating the Keyboard

The basic keys to navigate, select options and enter data are:

Function keys



The ON / OFF key turns the microprocessor and display on or off.

Note:The instrument oven and electronics power supply are on at all times.



The Enter key is used to acknowledge a particular keystroke sequence.



The MEASURE/CLR key is a dual function key. The MEASURE function is used to start measurements and the CLR function to move to the previous character field during data entry in alphanumeric fields. It also erases all values in certain fields, enabling entry of an entirely new set of values.

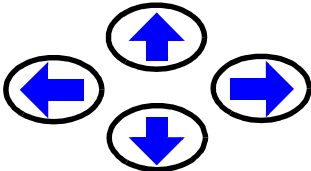

The arrow keys move the cursor either right, left, up or down.



The F1 to F5 function keys access the adjacent option on the display. These options will vary according to the current menu. For instance, in the SURVEY PARAMETER SETUP screen, the F1 key allows you to access the second parameters submenu.

Startup

Function/Alphanumeric Keys



Keying in the number 1, letters a, b and c as well as accessing the Setup screen.



Keying in the number 2, letters d, e or f.



Keying in the number 3, letters g, h and i.



Keying in the number 4, letters j, k and l as well as accessing the SETUP screen.



Keying in the number 5, letters m, n and o as well as accessing the RECALL screen.



Keying in the number 6, letters p, q and r as well as accessing the DISPLAY screen.



Keying in the number 7, letters s, t and u as well as accessing the INFORMATION screen.



Keying in the number 8, letters v, w and x as well as accessing the NOTE screen.



Keying in the number 9, letters y and z.



Keying in the number 0 as well as accessing the ESCAPE function.



Keying in a decimal as well as accessing the On-line Help information.

Direction/Sign Keys



Keying in the north direction, increasing the contrast or entering a + sign.



Keying in the south direction, decreasing the contrast and entering a - sign.



Keying in the east direction, increasing the contrast and entering a + sign.



Keying in the west direction, decreasing the contrast and entering a - sign.

Startup

Turning the CG-5 Display On

PRESS



To turn your CG-5 display and microprocessor on, *press* the ON / OFF key. The instrument temperature controller and most of the electronics are not affected by the ON/OFF key and remain powered up provided at least one charged battery and/or the external power supply are connected.



Note:

If your CG-5 does not turn on, or the screen is either totally blank or dark, please see Chapter 5, “Maintaining Your CG-5 and Trouble-shooting” and the “Trouble-shooting” topic on page 5-35.

Adjusting the Contrast

PRESS



If the screen is either too dark or too light, *press* the DISPLAY key. The following screen is displayed.

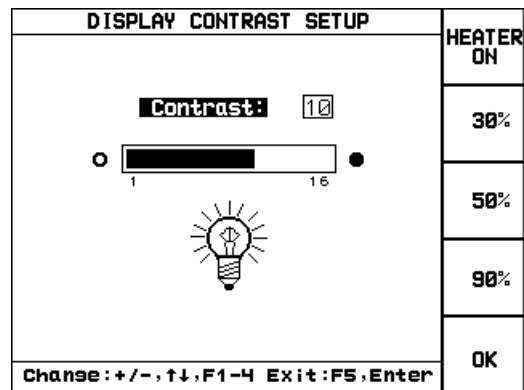

TO



The display contrast can be adjusted by either using the preset values F2 to F4.

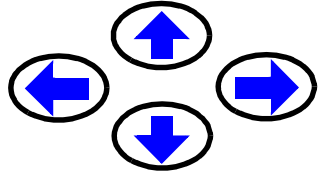

or by pressing the arrow keys.



Important:

Polarizing sunglasses may prevent you from seeing the screen, it will appear as all dark from some angles.

Display Heater

To maintain the effectiveness of the LCD display in cold weather, the CG-5 is equipped with a display heater. When the instrument is being used in a cold environment the display heater should be enabled by either:

- Pushing the F1 <HEATER ON> key in the display menu shown above or
- selecting the display heater option in the OPTIONS SCREEN

When the display heater is ON the temperature of the display is regulated so that it does not fall below -5 degrees C.

Startup

Working with the Display and Menus

The Autograv display is a quarter VGA. Typically, each screen has a screen title, data entry or setup area, selectable options to the right of the screen and navigation options to the bottom of the screen.







The following shows an example of the main measurement screen. This screen changes in appearance depending on which station designation system (ex. lat / long, UTM, etc.) you use.

STATION DESIGNATION		OPT ION
Station:	100042.	NEXT
Line:	40012.	LINE
Elevation:	284.	FUNCT
		EDIT
		NEXT
		STAT.
		LEVEL
Sel: ↑↓←→ Chs:Enter #		100%

The Autograv provides access to a variety of menus and submenus through selection of function keys F1 - F5.

Moving Between Menus: Example 1

In this example, we will move from the main measuring screen to a submenu using a function key. First start by turning the system on with the ON / OFF key. The system displays the main SETUP menu.

SETUP MENU			Check GPS
 Survey	 Autograv	 Options	
 Clock	 DUMP	 Memory	
	UTC: 18:40:28 Lat: 48°47'22.8"N Lon: -78°00'12.7"W Alt: 218.00 Sat: 0 Hdop: 0.3		
Service			OK
Sel: ←↑↓→ GoTo: F5, ←			100%

PRESS



Press the MEASURE CLR key. The system displays the following screen.

STATION DESIGNATION 14:45		
Eastings:	<input type="text" value="0.E"/>	OPTION
Northings:	<input type="text" value="0.N"/>	NEXT LINE
Elevation:	<input type="text" value="0."/>	FUNCT EDIT
Line ID:	<input type="text" value="100.N"/>	
Sel: ↑↓ Chs: Enter #		
		LEVEL

Startup

PRESS



Press the F1 <OPTION> key. The system displays the following screen.

DEFINE THE OPTIONS		
Read Time:	<input type="text" value="60"/>	
Factory Flag:	<input type="text" value="75"/>	
#Of Cycles:	<input type="text" value="0"/>	
Start Delay:	<input type="text" value="1"/>	
Line separation:	<input type="text" value="0."/>	
Station separation:	<input type="text" value="0."/>	FUNCT EDIT
Auto station inc.:	<input type="text" value="NO"/>	
Chart Scale:	<input type="text" value="1"/>	
Measurement:	<input type="text" value="GRAPHIC"/>	
LCD Heater:	<input type="text" value="OFF"/>	
Record Amb.Temp:	<input type="text" value="NO"/>	
Sel: ↑↓ Chs: Enter #		OK

Moving Between Menus: Example 2

In some cases, you may have to use other keys to position on a menu item before selecting it. This most commonly occurs with the SETUP screen. In this example, we assume that you are starting from this screen.

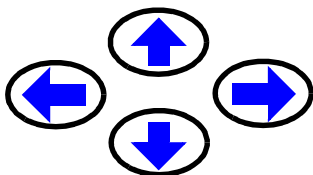

Press the arrow keys to bring you to an icon, for example, the Survey icon.

The word Survey is highlighted, as illustrated below.

Survey



Press the F1 key to access the Survey screen.

Moving Between Menus: Example 3

This example shows a final type of menu navigation method. First *press* the SETUP key to access the SETUP menu.

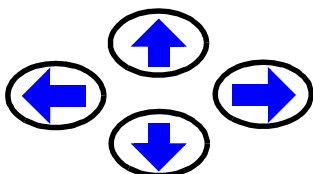

Press the arrow keys to bring you to an icon, for example, the SERVICE icon. The word Service is highlighted, as illustrated below.

Service



Press the ENTER key. The system displays the SERVICE menu.

Entering and Editing Information

There are several basic keyboard operations that will be repeated throughout the manual. These operations are as follows:

- Switching between preset values in fields,
- Editing fields,
- Entering alphanumeric values.

For purposes of clarity and brevity, we shall enumerate these procedures only once. Where in the manual these procedures are called upon, we shall refer to the present section.

Switching Between Preset Values in Fields

The simplest type of field entry is to switch between predefined values. As an example, start from the SETUP screen with the CG-5 turned on.

This screen appears automatically when the system starts or you can press the SETUP button from any screen to return to the screen.

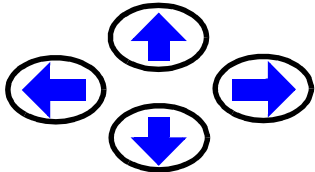

Press the arrow keys to bring your cursor to the Survey icon.

The word Survey is highlighted, as illustrated below.



PRESS

Press the ENTER key. The SURVEY HEADER screen is displayed.



PRESS

Press the F1 key. The system displays the following screen.

STATION DESIGNATION SYSTEM		
System: NSEWm		
SYSTEM	EXAMPLE ENTRY	
NSEWm	Line: 100N	
NSEWft	Station: 20S	FUNCT
XYm	Line: 100	EDIT
XYft	Station: -20	
UTMm	Eastings: 548906E	
	Northings: 548906S	
LAT/LONG	Longit.: 49E 50'34"	
	Latit.: 12N 13'22"	
Sel: ↑↓← Chg: ↔		OK

Press either the left or right arrow to change the designation system to LAT / LONG or another system such as NSEWm.

Entering Alphanumerics, Example 1

The alphanumeric keys allow you to enter four characters per key. The entered character depends on the number of times the key is pressed. For instance as you toggle the 2/DEF key you will successively obtain 2, d, e or f.

In this example, start from the SETUP screen again and select the Survey option. Press the ENTER key. The following screen is displayed:

SURVEY HEADER		25 °C
SurveyID:	Newton	PARAMS
Customer:	Scintrex	
Operator:	AM	
GRID REFERENCE:		
Latitude:	48.9N	READ GPS
Longitude:	78.6W	
Azimuth:	0.	FUNCT EDIT
Elevation:	0.	
UTM Zone:	0.	CANCEL
GMT Diff.:	5.	
Sel: ↑↓← Ch9: Alpha, ↔		OK

Startup

Press the F3 <FUNCT/EDIT> key to switch between the FUNCT and EDIT modes. The EDIT mode is highlighted as follows:

EDIT

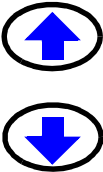

Press the up or down arrow keys to bring your cursor to the Longitude parameter.

PRESS 

Key in the value. For instance, for 27, press the 2 key,

PRESS 

and then *press* the 7 key.

PRESS



Press the E key. The new value is entered in the field.

You may want to experiment with entering other values by moving the arrow cursors to a new field. Press the F1 <OK> key when you are ready to continue.

Entering Alphanumerics, Example 2

This example illustrates the use of the clear all function to remove existing alphanumeric information from a field and also how to use Upper Case text.

As in the previous example, start in the SETUP menu and select the SURVEY option. Switch between the FUNCT and EDIT modes to access the EDIT mode.



Press the up or down arrow keys to bring your cursor to the Operator entry field.

PRESS



Press the F2 key to clear all of the data in the field.

PRESS 

Press the F1 key to activate the CAPS LOCK mode. The mode changes to the following:

CAPS
LOCK
on off

Type the first character that you would like to enter in the field. To advance your cursor, *press* the right arrow key. Type another character.

PRESS 

To return to lowercase, *press* the F1 key again to toggle back to lowercase characters, CAPS LOCK will then be set to off, as illustrated below.

CAPS
LOCK
on off

PRESS 

Press the 7/STU key until you obtain the letter t.

PRESS 

Press the ENTER key to acknowledge your choice.

PRESS 

When you are finished editing the parameter, *press* the F3 key to exit the EDIT mode.

Startup

Power Supply Status Icon

The status of the system power supply is given by the small icon which appears at the bottom of most CG-5 screens:

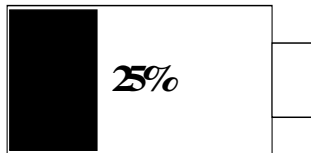

Powered by batteries

System running from the internal batteries - capacity is relative to two fully charged batteries e.g.:

- 100% = 2 fully charged batteries
- 50% = 1 fully charged battery
- 25% = 1 battery 50% capacity (as illustrated).

The system discharges the battery with the lower capacity first.



Charging Batteries

The external power supply is connected and is charging the batteries. The system charges the battery with the higher capacity first. When charging is complete the battery capacity icon appears. More details of system status during charging can be seen on the INFO screen.



Powered by External Supply

The system is powered by the external supply and no batteries are present

Accessing On-line Help

In addition to the Contrast Screen previously described, there are two other on-line display screens. These screens can be accessed at any time during the operation of the CG-5.

On-line Help

The help key line allows you to access help topics about the current screen being displayed.

PRESS



To access the on-line Help screen, *press* the HELP key.

The screen that will then appear will depend on the context in which the help key is pressed. For instance, if the HELP key was pressed in the SETUP Screen (SETUP key), the following screen would appear as an overlay.

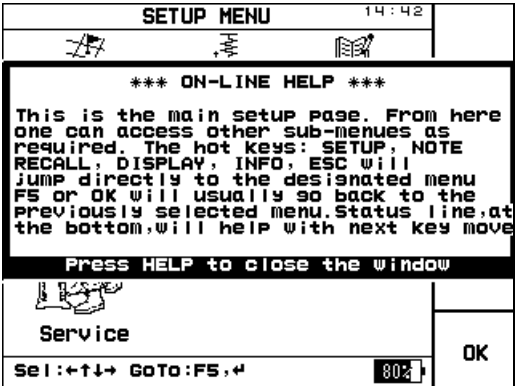

PRESS



To exit the on-line help, *press* the HELP key. The system returns to the previous screen.

Startup

Accessing System Information

The Information on-line screen presents details about your CG-5.

PRESS



To show the on-line information screen, *press* the INFO key. An overlay screen will appear as shown below.

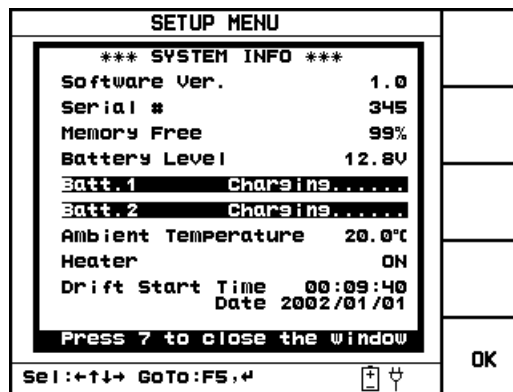

PRESS



Press the INFO key to return to the previous screen. If the battery status does not update press the button again.

Initializing Instrument Parameters

To prepare the instrument for field work, you must first initialize instrument and survey parameters. Some parameters, such as Autograv parameters (including tide corrections and instrument related parameters such as sensor tilts), may need to be set up only once. Others, such as Survey parameters, may require adjustment before each field survey. For more information, please see Chapter 2, “Setting Up Your Instrument.”

Checking Drift Corrections

We recommend that you check the instrument drift before using it initially and on an occasional basis to obtain best survey results. For details on these corrections, please see Chapter 5, “Maintaining Your CG-5 and Trouble-shooting” and the “Applying Drift Corrections” topic that starts on page 5-10.

Recalling and Plotting Data Onscreen

When the Autograv records a measurement, all information associated with that measurement (i.e. measured data, line and station numbers) are filed together. All of this information can be recalled and plotted easily to the display. This section describes basic procedures for reviewing measured data.

Showing Survey Parameters

This function gives you the ability to review basic parameters such as latitude and longitude, etc.

PRESS



Press the RECALL key. The system displays the following screen:

RECALL		16:34
Survey:	Default	SHOW SURVEY PARAMS
Line:	0.N	NEXT LINE
		FUNCT EDIT
		PLOT LINE DATA
		RECALL LINE DATA
Sel : ↑↓ → GoTo : F5 , ←		20%

PRESS



Press the F1 <SHOW SURVEY PARAMS> key. The system displays the following screen:

SHOW SURVEY PARAMETERS	
SurveyID:	a1
Customer:	
Operator:	
Longitude:	79.60E
Latitude:	43.90N
Azimuth:	0.0
Elevation:	0.00
UTM Zone:	0
GMT Diff.:	0.0
System:	NSEWmt
OK	

Startup

Plotting Profile Line Data

This function gives you the ability to see all points on a line so that you can review data quality and identify poor readings.

PRESS



Press the RECALL key. The system displays the RECALL screen.

PRESS



Press the F4 <PLOT LINE DATA> key. The system displays the following screen:

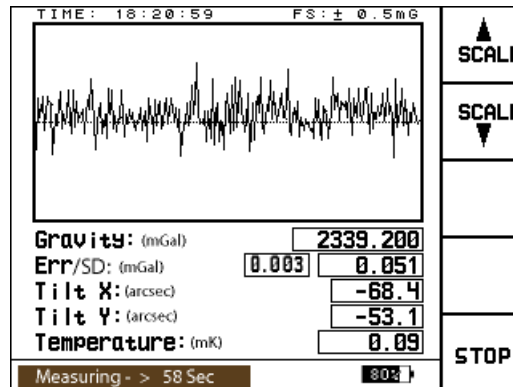

Use the F1 and F2 keys to increase and decrease the scale factor for the data profile.

Showing Numeric Line Data

This function gives you the ability to review numeric results for individual data points on specified lines.

PRESS



Press the RECALL key. The system displays the RECALL screen.

PRESS



Press the F5 <RECALL LINE DATA> key. The system displays the following screen:

AUTOGRAV RECALL DATA		RECALL NEXT POINT
ID	Data	
Grav.	2984.811	
S.D.	0.049	
TiltX	-0.611	
TiltY	-0.611	
Temp.	0.25	
E.T.C.	-0.086	
Dur.	64	
#Rej.	0 = 0.0%	
Time	19:18:41	
LineID	0.	
North.	200.S	
East.	100.E	
		OK

Startup

PRESS



Press the F1 <RECALL NEXT POINT> key to see the next set of points on the line.

Dumping Data

The CG-5 enables you to transfer/dump data via either a standard RS-232C port or via a USB port. Both options can be accessed through the SCTUTIL program which comes with your system and must first be installed on your computer.



Important:

Please note that your Norton Antivirus software may disrupt your downloading process.

- For information on the complete RS-232C and USB dump processes, see Chapter 3, “Operating the CG-5 in the Field” and the “Dumping Data” topic that starts on page 3-38.
- You will also find information on setting the baud rate and initializing the dump process in Chapter 2, “Setting Up Your Instrument” and the “Using the Dump Screen” topic that starts on page 2-25.
- For specific information on the SCTUTIL program, please see Appendix C, “Scintrex Utilities Program”.

2

Setting Up Your Instrument

Before you can initiate a gravity survey, you must be aware of the parameters that can be adjusted in your CG-5. They include:

- Survey parameters
- Autograv (field and instrument) parameters
- Read, cycling and base station options
- Real-time clock
- Dump settings
- Memory

This chapter describes changes that you make to your system using the main system setup screen and its submenus.

Accessing the Setup Screen

The SETUP screen is one of the key screens in the system. It provides access to five menus, each with its own submenus for configuring your CG-5.

To access the SETUP screen:

PRESS



Press the SETUP key. The following screen is displayed:

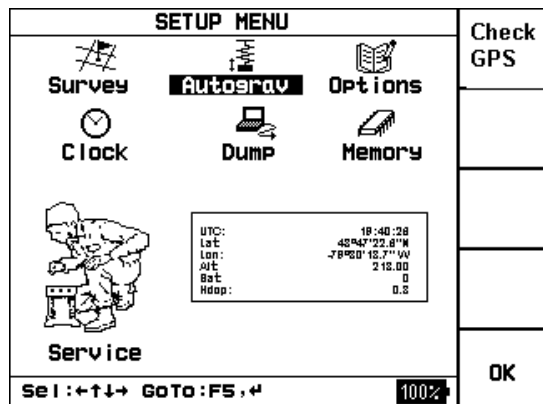

This is the main screen that will be referred to as the SETUP screen in this chapter and elsewhere in this manual.

Using the Survey Screen

The Survey setup screen enables you to create the survey header included in the data file. This includes the:

- Survey identifier
- Name of the client
- Name of the operator
- Grid reference point
- Station designation system

Specifying Header and Station Designation Information

The survey identifier and station designation system are required. The remaining information (i.e. client name, operator and the grid reference point parameters are optional - you can choose to enter or not enter any value for these parameters).

Setup

Specifying the Survey Identifier

To specify the Survey Identifier:

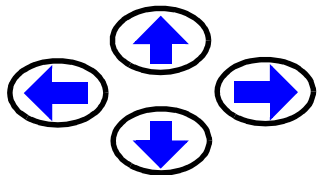

Use the arrow keys to position the cursor on the SURVEY icon.

PRESS



Press the F5 <or ENTER> key. The following screen is displayed:

SURVEY HEADER		25 °C
SurveyID:	Newton	PARAMS
Customer:	Scintrex	
Operator:	AM	
GRID REFERENCE:		
Latitude:	43.9N	READ GPS
Longitude:	79.6W	FUNCT
Azimuth:	0.	EDIT
Elevation:	0.	CANCEL
UTM Zone:	0	OK
GMT Diff.:	5.	
Sel: ↑↓ Chg: Alpha, ↔		

PRESS



Press the F3 <FUNCT/EDIT> key to highlight the EDIT function as follows.

EDIT



Press the up or down arrow keys to bring your cursor to the parameter (i.e. SurveyID) you want to modify. The selected parameter is highlighted as illustrated below:

SurveyID:

Enter the survey name as an alphanumeric value; this can be up to 19 characters long.

If you are unsure of how to enter information, please see Chapter 1, “Getting Started” and the “Entering and Editing Information” topic that starts on page 1-23.



Important:

The Survey identifier is required for any data file. You cannot use duplicate survey names. (i.e each survey identifier must be unique.)

PRESS

ENTER

When the survey name is correct, *press* the ENTER key to acknowledge your choice.

Specifying Optional Header Parameters

Should you wish to enter values for the other parameters, follow the same steps as mentioned for the Survey identifier. Allowed values are indicated below.

Client:

The client name can be any alphanumeric value up to 19 characters long.

Operator:

The operator name can be any alphanumeric value up to 19 characters long.

Specifying Grid Reference Point Parameters

If you want to include a grid reference point for your survey, you can specify the following parameters:

Easting:

The easting is the east coordinate of your grid reference point. This number can be set to any value from -999999 to 999999 (or E/W).

Northing:

The northing is the north coordinate of your grid reference point. This number can be set to any value from -99999999 to 99999999 (or N/S).

Azimuth:

The azimuth value is the direction, clockwise from true North, of your grid system.

Altitude:

The altitude is the value of the elevation of your grid reference point, either above mean sea level or relative to any particular point. This number can be set to any value from ± 50000 .

UTM Zone:

The UTM zone of your grid reference point. Consult the topographic map of your sector.

GMT Diff.:

The difference between your time zone and UTC time (Coordinated Universal Time).



Important:

The GMT Difference on points west of the Greenwich Meridian is positive and for points east of Greenwich it is negative.

PRESS



When you are finished editing the parameters, *press* the F3 <FUNCT/EDIT> key to exit the EDIT mode.

Specifying a Station Designation System

The system enables you to use six formats for specifying station designations as follows:

- NSEWm
- NSEWft
- XYm
- XYft
- UTMm
- LAT/LONG

To set the designation to the system you want to use for your survey, access the SURVEY HEADER screen by selecting the SURVEY icon in the SETUP menu.



Note:

When using the GPS receiver your station designation should be set to LAT/LONG. There are no UTM conversions or easting/northing designations available when you are using the GPS receiver.

PRESS



Press the F1 <PARAMS> key. The system displays the following screen:

14

STATION DESIGNATION SYSTEM		
SYSTEM	EXAMPLE ENTRY	
NSEWm	Line: 100N	FUNCT
NSEWft	Station: 20S	
XYm	Line: 100	EDIT
XYft	Station: -20	
UTMm	Eastings: 548908E Northings: 548906S	
LAT/LONG	Longit.: 49E 50'34" Latit.: 12N 13'22"	
Sel: ↑↓←→ Chg: ↔		OK

Setup

This screen shows the available options and provides example entries of each type of format.

If you are using a line-based system, the grid system can either be NSEW or XY. This means that your grid can be represented with or without cardinal point references.



Note:

In a NSEW grid system, north-south oriented lines will have an E or W suffix, depending if they are located either east or west of the grid origin. Similarly, east-west lines will have a N or S suffix, depending if they are located either north or south of the grid origin.

PRESS



Press the F3 <FUNCT/EDIT> key until the EDIT function is highlighted.

EDIT

The system also highlights the System: field as follows:

System:

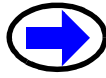

Use the left and right arrow keys to switch between designation systems. The System field is updated each time you press one of the arrow keys.

PRESS



When you are satisfied with your choice, *press* the F5 <OK> key.

Using the Autograv Screen

The Autograv parameter/setup are on two pages:

1. Corrections and filters.
2. Instrument parameters.

Specifying Corrections and Filters

Survey parameters that you can set in the system include:

- Tide Correction
- Continuous Tilt Correction
- Auto Rejection Filter
- Terrain Correction
- Seismic Filter
- Save Raw Data

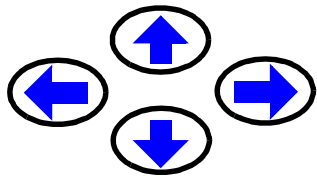

If the cursor is not already positioned on the AUTOGRAV icon in the SETUP menu, use the scroll keys to position the cursor.

To enable or disable a selection

PRESS



Press the F5 <or ENTER key>. The following screen is displayed:

AUTOGRAV SETUP		NEXT PAGE
Tide Correct.:	<input type="checkbox"/> YES	
Cont. Tilt. Corr:	<input type="checkbox"/> NO	
Auto Reject:	<input type="checkbox"/> YES	
Terrain Corr.:	<input type="checkbox"/> NO	FUNCT
Seismic Filter:	<input type="checkbox"/> YES	EDIT
Save Raw Data:	<input type="checkbox"/> NO	CANCEL
Sel: ↑↓ Chg: ↔		RECORD

PRESS



Press the F3 <FUNCT/EDIT> key to highlight the EDIT function as follows.

EDIT



Press the up or down arrow keys to bring your cursor to the parameter you want to modify.

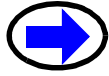
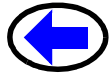

Use the left and right arrow keys to turn parameters to On or Off <YES or NO>. Parameters you can set are shown below.

Tide Correct. :

Standard earth tide correction generated using the latitude, longitude and difference between UTC. Based on Longman's formula.¹

Cont. Tilt. Corr:

Continuous compensation performed by meter at a rate of 6 Hz to account for minor variances in vertical tilt during a reading on unstable ground. If this function is disabled a tilt correction based on the last second of the reading is applied.

Auto Reject:

Automatic rejection of high frequency noise. Noise greater than 4 standard deviations or 6 standard deviations if the Seismic filter is enabled.

Terrain Corr. :

Correction of gravity for terrain effects according to standard Hammer computation.

Seismic Filter:

1.Longman, I. M., Journal of Geophysical Research, Volume 64, No. 12. Formulas for Computing the Tidal Accelerations Due to the Moon and Sun, December 1959.

The seismic filter eliminates low frequency caused by background seismicity or earthquakes. This is an averaging filter with tapered windows.

Save Raw Data:

Storage of unprocessed 6 Hz data in memory.

Specifying Instrument Parameters

Access the AUTOGRAV SETUP screen using the Autograv menu as described above.

PRESS



Press the F1 <NEXT PAGE> key. The system displays the following screen:

AUTOGRAV SETUP	
Gref.:	0.
G. Cal1:	8078.
TiltX.Sens:	570.7
TiltY.Sens:	281.
TiltX.Offs:	-26.4
TiltY.Offs:	81.8
Tempco:	-0.125
Drift:	0.1
Drift Start TM/DT:	10:42:48 2003/04/02
Sel:↑↓ Ch9:Enter # 502	

FUNCT
EDIT
OK



Important:

DO NOT change the CG-5 parameters to those illustrated above. These values are instrument specific and are printed on a label with each instrument. In addition we provide a parameter sheet with the instrument.

PRESS



Press the F3 <FUNCT/EDIT> key to highlight the EDIT function as follows.

EDIT



Press the up or down arrow keys to bring your cursor to the parameter (ex. Gref:) you want to modify.

Gref:

Constant offset subtracted from gravity readings.

G.Cal1:

Instrument scale factor.

TiltX.Sens:

X tilt sensor sensitivity.

TiltY.Sens:

Y tilt sensor sensitivity.

**Important:**

If you set the TiltX.Sens or TiltY.Sens parameters to zero then the sensitivity function will become disabled, and you will not be able to level your CG-5.

TiltX Offs:

Aligns the X tilt sensor with the gravity sensor.

TiltY.Offs:

Aligns the Y tilt sensor with the gravity sensor.

Tempco:

Temperature coefficient of the gravity sensor in mGal/degrees MK.

Drift:

Long term instrument drift due to stress relaxation in the elastic (quartz) system. Units are in mGal/day.

Drift Start TM/DT:

Set the drift start time to the current time.

Note:

The drift start time changes automatically to the current time when the memory is cleared.



PRESS



When finished, *press* the F5 <OK> key. The system returns to the previous menu.

Saving Changes to Parameters

If you have made changes to either the corrections and filters or instrument parameters as described above, you must save these changes before they are initiated in your next survey.

PRESS



In the AUTOGRAV PARAMETER SETUP screen, *press* the F5 <RECORD> key. The changes are saved.

Cancelling Changes to Parameters

If you have made changes but decide you want to undo your changes, *press* the F4 <CANCEL> key in the AUTOGRAV PARAMETER SETUP screen.

PRESS



Using the Options Screen

The Options setup item enables you to set recording parameters, including:

- Read times
- Factory Flag
- Number of cycles
- Start delay
- Line Separation
- Station separation
- Auto station increment
- LCD Heater
- Record ambient temperature

This section describes the allowed values and the effect of using each option in a survey.

Defining Reading and Cycling Options

The CG-5 has a number of reading modes:

- for single readings choose an appropriate **read time** Number of cycles

You also have two options for carrying out repeat readings at the same station:

- Auto - repeat mode: set the **# of Cycles** to any value between 1 and 99998 and the reading will be repeated for the cycle number - e.g. if **# of Cycles** is set to 2, two readings will be made. The interval between the start of consecutive readings will be **Read Time** + 3 seconds.

Defining Reading Options

To define these values:

Use the arrow keys to navigate to the Options item. The word Options is highlighted as follows:

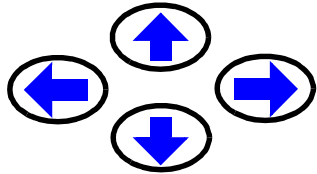

Options

PRESS **F5**

Press the F5 <or ENTER> key. The following screen is displayed:

DEFINE THE OPTIONS		
Read Time:	<input type="text" value="60"/>	
Factory Flag:	<input type="text" value="75"/>	
#Of Cycles:	<input type="text" value="0"/>	
Start Delay:	<input type="text" value="1"/>	
Line separation:	<input type="text" value="0."/>	
Station separation:	<input type="text" value="0."/>	FUNCT
Auto station inc.:	<input type="text" value="NO"/>	EDIT
Chart Scale:	<input type="text" value="1"/>	
Measurement:	GRAPHIC	
LCD Heater:	<input type="text" value="OFF"/>	
Record Amb.Temp:	<input type="text" value="NO"/>	
Sel: ↑↓← Chg:Enter #		OK

Setup



Note:

The Factory Flag item has no user functionality.

PRESS **F3**

Press the F3 <FUNCT/EDIT> key to highlight the EDIT function as follows:

EDIT



Press the up or down arrow keys to bring your cursor to the parameter you want to modify. Following is a list of parameters and values. Note that when you select a parameter, the cursor is automatically positioned in the field ready for editing.

Read Time:

Duration in seconds over which you want to record data. Allowed values are from 1 to 256.



Note:

The minimum value must be 20 s greater than the specified read time (to allow for instrument-related data management activities).

If you set a cycle time of 2000 s, the system would record a reading every 2000 s.

#of Cycles:

Number of times a reading is automatically repeated in auto-repeat mode. Also activates the base station mode (by entering 99999). Allowed values are 0 to 99998.

Start Delay:

Used when the operator wants to allow time for the ground around the meter to settle prior to measurement. Allowed values are 1 to 99 s.

Line separation:

Separation in metres between survey lines. Controlled by pressing the Next Line function on the STATION DESIGNATION (i.e. main measurement) screen.

Station separation:

Separation in metres between stations. Enabled by entering a value and setting Auto Station Increment to On.

Auto station inc.:

Select whether auto station incrementation is enabled or disabled. When enabled, the system automatically increments to the next station after a cycle of measurements is recorded.

Other settings in the Options menu are:

- Chart Scale - contact Scintrex regarding the Chart Recorder option.
- Measurement Screen - select either the Numeric or Graphic measurement screen.
- LCD heater - enables the LCD Heater for cold weather operation.
- Record Ambient Temp: Records the ambient temperature in place of Altitude.

PRESS



When finished editing, *press* the F5 <OK> key to save your changes.

Using the Clock Screen

The clock screen allows you to adjust the internal real-time clock. The CG-5 clock is powered by a battery attached to the CPU. In the event that the main batteries run out, the clock setting remains active and does not need to be reset. You can also synchronise the CG-5 real-time clock with a GPS signal.



Note:

Time and date as determined by this clock will be included in the data files.

To set the clock:

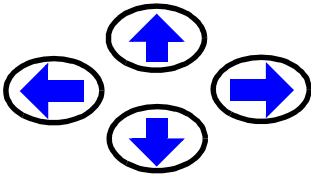

In the Setup screen, *press* the arrow keys to bring the cursor to the CLOCK icon.

The word Clock is highlighted, as illustrated below.

Clock

PRESS



Press the F5 <or ENTER> key. The following screen is displayed:

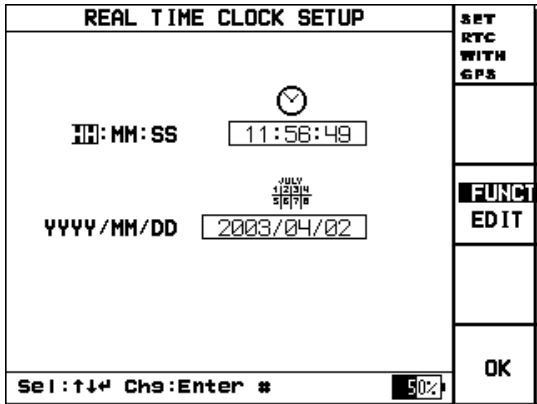

Setup

Automatic setting of time and date

PRESS



Press the F1 or <SETRTC WITH GPS> key to automatically synchronise the CG-5 real-time clock with the GPS signal.

Manual setting of time and date



Press the up or down arrow keys to move between the time and the date.



Press the right or left arrows to move between either of the three parameters ex. Hours, minutes or seconds.

Setting Up Your Instrument

PRESS



Press the F3 <FUNCT/EDIT> key to choose the EDIT mode.

Enter the time as a numeric parameter.

Repeat the previous procedure for the minutes and seconds values.

PRESS



When you are finished editing the parameters, *press* the F5 <OK> key. The system returns to the SETUP menu.

Using the Dump Screen

The dump screen enables you to set the baud rate for communicating via an RS-232C standard connection.

**Important:**

This screen is NOT applicable for dumping via the USB port. For information on USB dumping, please see “Dumping Data” on page 3-38.

Setting Up for Data Dumping via RS-232C

The following sections relate to RS-232 dumping. To dump via RS-232C, you must set communication parameters (i.e. baud rate) BOTH on the CG-5 and then in the SCTUTIL program which controls the actual dumping process.

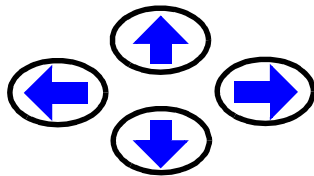

Setting the Baud Rate

Use the arrow keys to navigate to the DUMP icon in the SETUP screen. The word Dump will then be highlighted, as illustrated below:

Dump

PRESS 

Press the F5 <or ENTER> keys. The following screen is displayed.

DUMP PARAMETER SETUP		
Baud rate:	<input type="text" value="9600"/>	START DUMP
Data bits:	8	
Parity check:	NO	
Stop bits:	1	FUNCT
Data format:	BINARY	EDIT
Ch9: ↔		OK

PRESS 

Press the F3 <FUNCT/EDIT> key to choose the EDIT mode.

The baud rate parameter is highlighted as illustrated below. It is the only parameter that can be edited on this screen:

Baud Rate:



Press the right or left arrows to select one of the predefined baud rates. Allowed values are 600, 1200, 2400, 4800, 9800, 19200, 38400 and 57600.

PRESS 

When you have selected the correct rate for your personal computer, *press* the F5 <OK> key.

Starting a Dump

An instrument dump is also initiated from the DUMP PARAMETER SETUP screen. For more details, see “Dumping Data using the RS-232C Port” on page 3-38.

Using the Memory Screen

The CG-5 is equipped with 12 MB of FLASH memory. The current available memory can be displayed or the memory can be cleared following data dumping to enable additional data to be recorded.

Working with the Memory

At the start of each day ensure that there is adequate storage space for the day's data. If there is insufficient memory available, then erase the memory.

Erasing the memory does not erase initialization, setup or position parameters. However, all the recorded measurements in the memory will be lost and your drift start time will be reset to the current time. Please ensure that you have transferred the data to your computer or printed them out.

Accessing the Memory Option

To access this option:

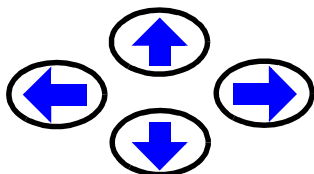

Press the arrow keys in the SETUP screen to navigate to the MEMORY icon to highlight the item as follows:

Memory

PRESS



Press the F5 <or ENTER> key. The following screen is displayed:

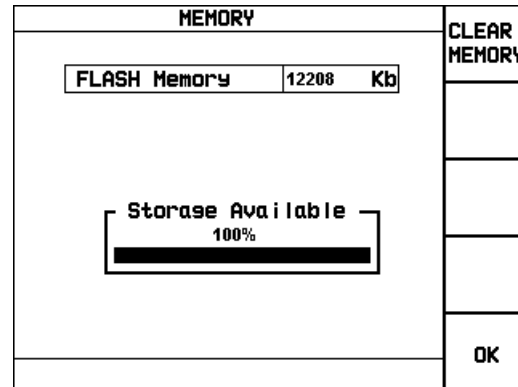

Setup

Exiting without Clearing Memory

PRESS



If you want to simply check the memory without clearing it, *press* the F5 <OK> key. The system returns you to the OPTIONS menu.

Clearing Memory

To ensure that memory is not cleared by accident, the process to clear memory requires multiple keystrokes.

First access the MEMORY screen and then:

PRESS



Press the F1 key.

Setting Up Your Instrument

PRESS  *Press* the F3 key.

PRESS  *Press* the F2 key.

PRESS  *Press* the F4 key.

The system displays an Erasing message and updates the storage available.

PRESS  *Press* F5. The system returns to the SETUP menu.

Using the Service Screen

Scintrex is pleased to respond to your service requests around the world. The company also takes pride in providing periodic upgrades to its products and software to deliver the latest technologies to our customers.

Accessing Service Options

The service screen allows you to:

- view the addresses of the Scintrex offices throughout the world
- upgrade your current software version
- activate user calibrations (ex. drift or tilt corrections).

Accessing the Service Screen

To access the SERVICE screen:

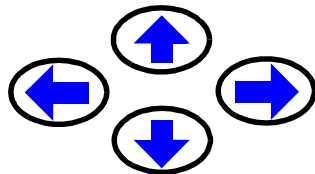

In the set-up screen, *press* the arrow keys to bring the cursor to the service icon.

The word Service is highlighted, as illustrated below.

Service

PRESS 

Press the F5 <or ENTER> key. The following screen is displayed:

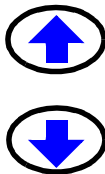
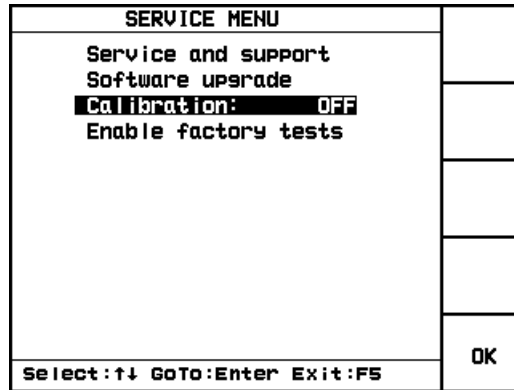

Press the up or down arrow keys to toggle between the available options.

PRESS 

Press the F5 <or ENTER> key to select the operation you want to perform.

Service and support

The service and support item lists the locations of our offices worldwide.

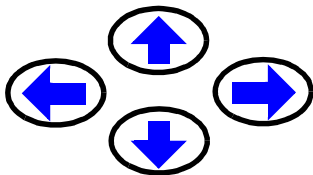

Press the arrow keys to bring the cursor to the service and support line.

The phrase “service and support” will then be highlighted, as illustrated below:

Service and Support

PRESS



Press the ENTER key.

The following screen will then appear.

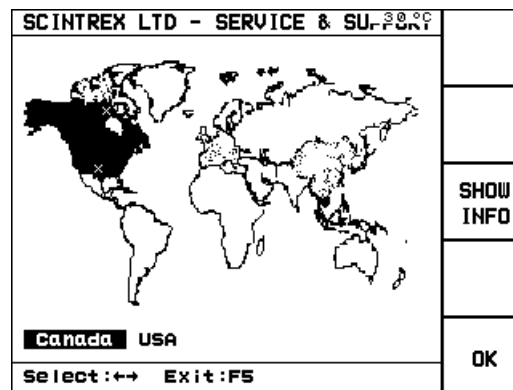

Canada

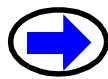
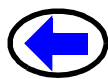

To find contact information about the Canadian office, use the right or left arrows to toggle to the word Canada.

The word Canada will then be highlighted, as illustrated below:

Canada

PRESS



Press the F3 <SHOW INFO> key to show the information about this office.

The following screen will appear.

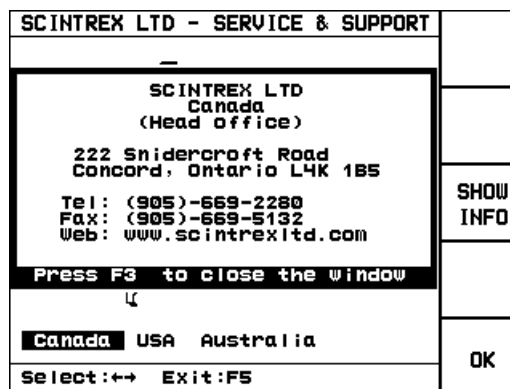

PRESS



Press the F3 <SHOW INFO> key to close this window.

You can repeat the above-mentioned steps for our USA office.

Software Upgrade

The software upgrade selection allows you to upgrade your CG-5 to the current software version using either an RS232C or USB port. For a complete description of the upgrade procedure, please see “Reprogramming your CG-5” on page 3-57.

User Calibration

The User Calibration option enables you to select from three periodic maintenance checks (tilt offsets and sensitivities as well as drift corrections). For more details on these checks, please see Chapter 5, “Maintaining Your CG-5 and Trouble-shooting”

Enable Factory Test



Important:

This option is only available to Scintrex Customer Service authorized personnel. This function is not to be accessed by our customers.

Setting Up Your Instrument

3

Operating the CG-5 in the Field

By now you have familiarized yourself with your CG-5 and set up the instrument parameters. This chapter reviews the basic steps required to carry out a field survey and remote operation. Basic survey steps include:

- Initialize parameters
- Place the Autograv on the tripod
- Level it using the tripod footscrews
- Set up terrain corrections (optional)
- Initiate the reading
- Wait until the measurement stops automatically, or stop the reading manually
- Add any required notes
- Recall your data
- Dump your data
- Clear memory

Initializing Field Parameters

There are three sets of parameters to be initialized prior to performing a field survey. Some of these you may already have completed by now but we provide a quick summary for completeness. Parameters include:

- Autograv parameters
- Survey parameters
- Read time, cycle time, Auto Station increment in the OPTIONS screen.

Setting up Autograv Parameters

Before you begin your survey, you may want to check that you have initialized all required Autograv parameters. These include:

- Tide Corrections
- Continuous Tilt Correction
- Auto Rejection
- Terrain Correction
- Seismic Filter
- Save Raw Data

For a description of the initialization process, please see Chapter 2, “Setting Up Your Instrument” and the “Using the Autograv Screen” on page 2-11.

Setting Up Survey Parameters

For field surveys, key parameters that you must set include the SurveyID and Station Designation System.

Setting Up Survey Options

Key options that you will need to set up or consider setting up include the read time, cycle time and auto station increment.

They can be set up with either the options menu or immediately prior to the measurement using the F1 <OPTIONS> key that appears on the right of the main measuring screen (i.e. STATION DESIGNATION screen). For more information on setting these parameters, please see Chapter 2, “Setting Up Your Instrument” and “Using the Options Screen” on page 2-18.

Working with Station Designation Systems

Before you can begin your survey, you will need to provide starting coordinates, or line and station values (depending on the station designation system you are using).

Depending on how you have set up your survey, you may have to increment your stations and lines manually or they may be incremented automatically. The station numbering scheme is determined by the station designation mode that you have selected.

- If you select the Auto station inc. feature in the Options menu, the station number is automatically incremented by an amount equal to the Station separation entry
- If you disable the feature, you can change the station number by editing stations or lines, or by using the arrow keys to change the station setting by an amount equal to the station separation entry

This section describes how to edit each of the four types of modes manually. For more information on selecting a station designation system and examples, see Chapter 2, “Setting Up Your Instrument” and the topic “Specifying a Station Designation System” on page 2-8.

PRESS





ON / OFF

Press the ON / OFF key.

The screen that the system will display depends on the station designation system you have selected, as per the topic “Specifying a Station Designation System” on page 2-8.

Editing XY Stations and Lines

This section assumes that you have selected the XYm or XYft station designation system.

STATION DESIGNATION		
Station:	<input type="text" value="100042."/>	OPTION
Line:	<input type="text" value="40012."/>	NEXT LINE
Elevation:	<input type="text" value="284."/>	FUNCT EDIT
		NEXT STAT.
		
Sel: ↑↓ Chg: Enter #		LEVEL

PRESS



Press the F3 <FUNCT/EDIT> key to highlight the EDIT function as follows:

EDIT



Press the up or down arrow keys to bring your cursor to the parameter (ex. Station:) you want to modify.

The selected parameter is highlighted as indicated below:

Station:

PRESS



Press the MEASURE CLR key to remove any existing values in the field.

Type the station value followed by either a + or - to indicate whether the station is increasing or decreasing along the line.

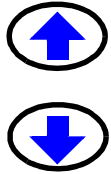

Use the arrow keys to move to the Line field and repeat this process as required.

PRESS



Press the F3 <FUNCT/EDIT> key to save your changes.

Editing NSEW Stations and Lines

This section assumes that you have selected the NSEWm or NSEWft station designation system.

STATION DESIGNATION 14:45		OPTION
Eastings:	<input type="text" value="0.E"/>	NEXT LINE
Northings:	<input type="text" value="0.N"/>	FUNCT EDIT
Elevation:	<input type="text" value="0."/>	
Line ID:	<input type="text" value="100.N"/>	
Sel: ↑↓ Chg: Enter #		LEVEL

Operations

PRESS



Press the F3 <FUNCT/EDIT> key to highlight the EDIT function as follows:

EDIT

Operating the CG-5 in the Field



Press the up or down arrow keys to bring your cursor to the parameter (ex. Easting:) you want to modify.

The selected parameter is highlighted as indicated below:

Easting:

PRESS



Press the MEASURE CLR key to remove any existing values in the field.

Type the easting value followed by either a E or W to indicate whether the station is in the east or west quadrant.



Use the arrow keys to move to the Northing field and repeat this process as required.



Note:

The Line values must be opposite to the direction selected for the station (i.e. if you have selected N and S for stations, then lines must be designated as E and W).

PRESS



Press the F3 <FUNCT/EDIT> key to save your changes.

Editing LAT/LONG Stations and Lines

This method assumes that you have selected the LAT/LONG station designation system.

STATION DESIGNATION				27 °C
	Des°	Min'	Sec"	
Longitude	0E	0	0.	
Latitude	0N	0	0.	
Elevation:			0.	
Line ID:			0.?	
Sel: ↑↓ Chs: Enter #				30%

OPTION

NEXT LINE

FUNCT EDIT

READ GPS

LEVEL

PRESS



Press the F3 <FUNCT/EDIT> key.

The selected parameter is highlighted as indicated below:

Longitude

PRESS



Press the MEASURE CLR key to remove any existing values in the field.

Type the degree value in the Longitude field.

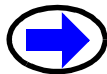

Use the arrow keys to move to the minutes and seconds fields for data entry.

Operating the CG-5 in the Field

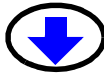

Use the arrow keys to move to the Latitude field and repeat this process used for Longitude data entry as required.

Note:

You can also specify an optional Line ID if required.

PRESS



Press the F3 <FUNCT/EDIT> key to save your changes.

Editing UTM Stations and Lines

This method assumes that you have selected the UTM station designation system.

STATION DESIGNATION		27 °C	
Eastings:	1000042E	OPTION	
Northings:	322222N	NEXT LINE	
Elevation:	1000	FUNCT EDIT	
Line ID:	10N		
Sel: ↑↓ Chs: Enter #		30%	LEVEL

PRESS



Press the F3 <FUNCT/EDIT> key.

The selected parameter is highlighted as indicated below:

Easting



Press the MEASURE CLR key to remove any existing values in the field.

Type the easting value followed by either a E or W to indicate whether the station is in the east or west quadrant.



Use the arrow keys to move to the Northing field and repeat this process as required.



Note:

The Line values must be opposite to the direction selected for the station (i.e. if you have selected N and S for stations, then lines must be designated as E and W).



Press the F3 <FUNCT/EDIT> key to save your changes.

Setting Up the Tripod

The tripod serves two functions:

1. It provides a stable base for the instrument in the field, where the ground is generally uneven and of variable hardness.
2. It enables the operator to precisely level the gravimeter by rotating the footscrews

In field operations the tripod is stabilized by treading on the frame next to each of the legs to push the steel tipped points into the ground. The base can be roughly levelled by using the bubble. Where the ground surface is very unstable, soft or difficult to reach it is recommended that the standard tripod be attached to the optional surveyor's tripod.





Figure 4 - Setup of the Tripod

Setting up the CG-5 on the Tripod

The gravimeter is placed onto the tripod so that the hardened conical, vee groove and flat surfaces on the base of the gravimeter fit onto the spherical ends of the tripod footscrews. The weight of the meter firmly "locks" it onto the tripod, while the kinematic design allows it to be freely levelled.

When the gravimeter is set up on the tripod *press* the MEASURE key and the STATION DESIGNATION screen appears.

STATION DESIGNATION		
Station:	<input type="text" value="100.E"/>	OPT ION
Line:	<input type="text" value="200.S"/>	NEXT LINE
Elevation:	<input type="text" value="1000."/>	FUNC EDIT
		NEXT STAT .
		 LEVEL
Sel : ↑↓ ← Chg : Enter #		

Operating the CG-5 in the Field

If you have enabled the terrain correction process, you will notice that a TERCOR option is enabled before the LEVEL option, as illustrated below.

STATION DESIGNATION 16:06

Station: 100.E

Line: 200.S

Elevation: 1000.

OPTION

NEXT LINE

FUNC EDIT

NEXT STAT.

31°

Sel: ↑↓ Chs: Enter # 30% TERCOR

In this screen the station, line and elevation information can be entered. Note that Ambient Temperature appears in place of the Elevation if the Record Ambient Temperature option is selected in the Options Screen.



Note: The Options Screen can be easily accessed at this point by pushing the F1 key.

If you have not enabled the terrain correction process, please proceed immediately to “Leveling the CG-5” on page 3-16.

Applying Terrain Corrections

One of the features incorporated into the CG-5 is the ability to apply terrain corrections to gravity data. The method is based on the standard Hammer computation¹ with four zones around the reading point. The computation requires a ground density as well as inclination readings for specified points at different preset distances from the reading point.

1. Hammer, S. 1939. Terrain corrections for gravimeter stations. Geophysics Vol. 4, pp 962-971.



Note:

Terrain corrections must be turned on using the AUTOGRAV menu. After being turned on, they are inserted as an additional step during each measurement step (i.e. before leveling). Where survey speed is required, you may wish to disable the Terrain Correction option.

If you have enabled this process, you will notice that a TERCOR option is enabled before the LEVEL option. Otherwise, this option is not displayed.

Entering Ground Density and Zones

Terrain corrections require entry of the following at each station:

- Ground density
- B zone inclinations
- C zone inclinations
- D zone inclinations

Entering Ground Density

This method assumes that you have the Terrain Correction option enabled.

PRESS

**MEASURE
CLR**

Press the MEASURE CLR key. The system displays the following screen:

STATION DESIGNATION 15:46		OPTION
Eastings:	1000042.E	NEXT LINE
Northings:	322222.N	FUNCT EDIT
Elevation:	1000.	
Line ID:	10.N	
Sel: ↑↓ Ch9:Enter #		TERCOR

PRESS

F5

Press the F5 <TERCOR> key. The system displays the following screen:

NEAR TERRAIN CORRECTIONS		ENTER GROUND DENSIT
		ZONE B
		1
		0.0000
		0.0000
		0.0000
		0.0000
		ENTER B ZONE
		ZONE C
		1
		0.0000
		0.0000
		0.0000
ENTER C ZONE		
ZONE D		
1		
0.0000		
0.0000		
0.0000		
0.0000		
ENTER D ZONE		
DENSITY	1.0	LEVEL

PRESS

F1

Press the F1 <ENTER GROUND DENSIT> key. The system displays a small window near the top right of the screen.

Enter a ground density.

PRESS 

When satisfied with the entered value, *press* the F5 <OK> key. The system returns to the Near Terrain Corrections screen.

Entering B Zone Inclinations

This method assumes that you are still in the Near Terrain Corrections screen.

PRESS 

Press F2 <ENTER B ZONE> key. The system displays a small window near the top right of the screen.

Enter an inclination value in the first field.

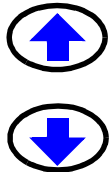

Use the arrow keys to move to the remaining fields required for data entry.

PRESS 

When satisfied with all entered values, *press* F5 <OK> key. The system returns to the Near Terrain Corrections screen.

Leveling the CG-5

PRESS



Press the MEASURE CLR key again (alternatively *press* the F5 <LEVEL> key) and the following screen appears:

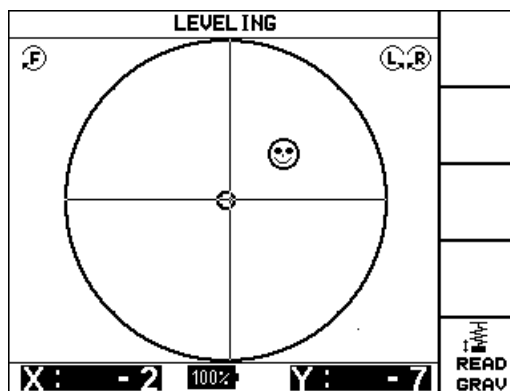

The instrument can now be leveled by rotating the footscrews in the directions indicated by the icons on the top corners of the screen. The orientation is shown in arcseconds at the bottom of the screen and by the cross-hairs. The definition of the axes of rotation and the sign convention is shown in the illustration below. Continue rotating until the intersection of the cross-hairs is within the small circle in the center (± 10 arcsec). You are now ready to start a reading.

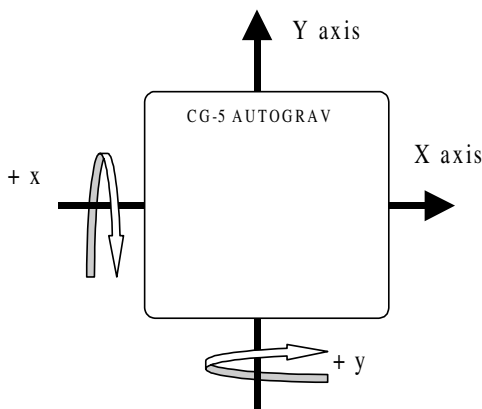

Figure 5 - Levelling Axes

**Hint:**

Level the Y axis (vertical cross-hair) first and then the X axis.

You are now ready to acquire data.

Performing Data Acquisition

Two screens for data acquisition are available in the Measurement parameter of the OPTIONS SCREEN:

1. Graphic screen - allows the operator to view the raw gravity data in graphical form as it is acquired at 6 samples per second and to review the graph before deciding whether or not to save the reading.
2. Numeric screen - shows the numeric value of the average gravity reading as it is being acquired, together with the last five gravity values.

From either screen you can easily review the last hundred or so readings before deciding whether or not to save the current reading.

Taking a Reading - Graphics Screen

This method assumes that:

- You have selected the GRAPHIC Measurement mode in the OPTIONS SCREEN
- You have just leveled your instrument, are in the STATION DESIGNATION screen and have designated station and line information.

PRESS



Press the F5 <Read> key or the MEASURE key. The following screen is displayed:

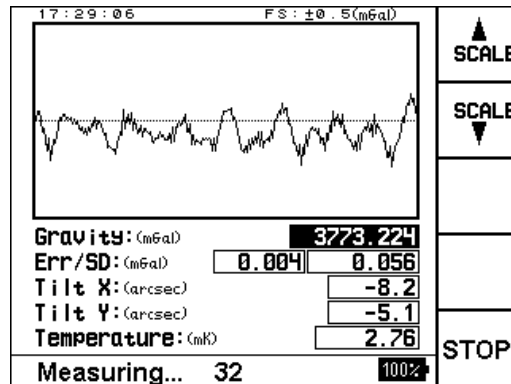

The 6 Hz raw output of the gravity sensor is displayed graphically in ‘real time’ with an update rate of approximately once per second. The full scale of the graph (FS) is shown in the top right hand corner of the screen and can be adjusted up or down using the F1 and F2 <SCALE> keys.

The system continues to measure until the read time is elapsed. Note that if the instrument is in auto-repeat or base station mode it will keep reading until the last cycle is completed (or the F5 <STOP> key is pushed). The Read Time, Cycle Time and Number of Cycles are set through the OPTIONS screen. For more details, see Chapter 2, “Setting Up your Instrument” and the “Using the Options Screen” topic that starts on page 2-15.

Note:



You can also stop your reading at any time during the reading process by pressing the F5 <STOP>key.

Reviewing Raw Data

When the measurement is stopped automatically or manually, the system updates the display as shown below:

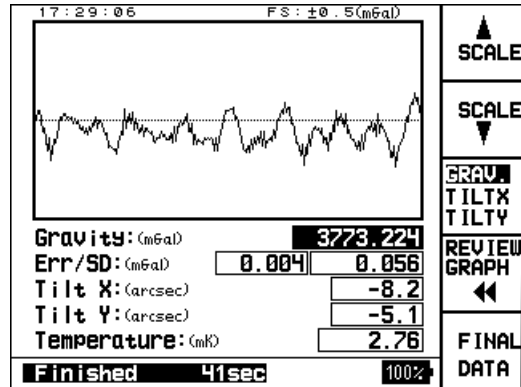

Before calculating the final data the gravity, tiltx and tilty graphs for the last reading can be reviewed using the F3 and F4 keys.

Reviewing Final Data

PRESS



Press the F5 <FINAL DATA> key. The following screen is displayed. The **Current** column contains the current gravity value after filtering and with all corrections applied together with the other measured variables, time and station information. Initially the last recorded reading is displayed in the **Preceding** column. The last one hundred or so readings can be recalled sequentially and displayed in the **Preceding** column using the scroll up and down keys.

AUTOGRAV FINAL DATA			
ID	Precedins	Current	
Grav.	2339.267	2339.252	
S.D.	0.049	0.051	
TiltX	-2.824	-2.824	
TiltY	12.435	12.435	
Temp.	0.09	0.09	
E.T.C.	-0.028	-0.034	
Dur.	64	64	
#Rej.	0 = 0.0%	0 = 0.0%	
Time	18:11:42	18:20:59	CANCEL
Line	0.S	0.S	
Stat.	0.W	0.W	RECORD

Recording Data

After reviewing data in the AUTOGRAV FINAL DATA screen you can record it:

PRESS



Press the F5 <RECORD> key. The system stores the data and returns you to the STATION DESIGNATION screen so that you can continue with your next measurement.



Note:

You can use the F1 and F2 keys during a reading to increase or decrease the viewing scales as desired. The F4 key also enables you to quickly replot the data if required.

Canceling Data

If you are not satisfied with your data in the Autograv Final Data screen:

PRESS



Press the F4 <CANCEL> key. The system returns you to the main SETUP menu without saving data.

Taking a Reading - Numeric Screen

This method assumes that:

- you have selected the NUMERIC Measurement mode in the OPTIONS SCREEN
- you have just leveled your instrument, are in the STATION DESIGNATION screen and have designated station and line information.

PRESS



Press the F5 <Read> key or the MEASURE key. The following screen is displayed:

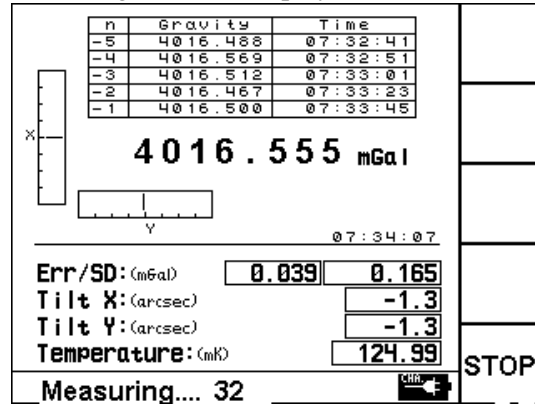

Operations

The running average of the uncorrected gravity reading is displayed in large numerals at the centre of the display. The previous five final gravity readings are displayed in the table at the top of the display.

The system continues to measure until the read time is elapsed. Note that if the instrument is in auto-repeat mode it will keep reading until the last cycle is completed (or the F5 <STOP> key is pushed). The Read Time, Cycle Time and Number of Cycles are set through the OPTIONS screen. For more details, see Chapter 2, “Setting Up your Instrument” and the “Using the Options Screen” topic that starts on page 2-15.



Note:

You can also stop your reading at any time during the reading process by pressing the F5 <STOP>key.

Reviewing Raw Data

When the measurement is stopped automatically or manually, the system updates the display as shown below:

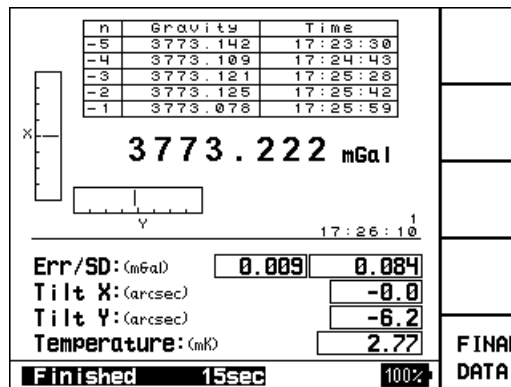

The final data can be calculated as described below:

Reviewing Final Data

Press the F5 <FINAL DATA> key. The following screen is displayed. The **Current** column contains the current gravity value after filtering and with all corrections applied together with the other measured variables, time and station information. Initially the last recorded reading is displayed in the **Preceding**

PRESS



column. The last one hundred or so readings can be recalled sequentially and displayed in the **Preceding** column using the scroll up and down keys.

AUTOGRAV FINAL DATA		
ID	Preceding	Current
Grav.	2339.267	2339.252
S.D.	0.049	0.051
TiltX	-2.824	-2.824
TiltY	12.435	12.435
Temp.	0.09	0.09
E.T.C.	-0.028	-0.034
Dur.	64	64
#Rej.	0 = 0.0%	0 = 0.0%
Time	18:11:42	18:20:59
Line	0.S	0.S
Stat.	0.W	0.W

Recording Data

After reviewing data in the AUTOGRAV FINAL DATA screen you can record it:

PRESS



Press the F5 <RECORD> key. The system stores the data and returns you to the STATION DESIGNATION screen so that you can continue with your next measurement.

Canceling Data

If you are not satisfied with your data in the Autograv Final Data screen:

PRESS



Press the F4 <CANCEL> key. The system returns you to the main SETUP menu without saving data.

Starting the Next Measurement

The CG-5 is configured so that when you turn the instrument off, it turns on again at the previous screen you were using. If you have just finished a measurement, you will return to the measurement screen. This simplifies setting up the instrument and speeds up the measurement process.

Depending on whether you have set the instrument for automatic station incrementation or not, you may have to enter a new station (and / or line) number. Information on editing station designations is provided earlier in this chapter.

Entering Notes

During the course of your survey, you may want to enter notes regarding cultural or topographic features that were encountered. These notes can be entered at any time during your survey and are stored in a sequential fashion, i.e. just after the last measurement collected.

Recording Notes

The notes that you will record in your data file can be:

- Note selected from the pre-defined list. This list is comprised of 24 items. or,
- One of five macros or,
- Manually entered text not included in the pre-defined list of features nor in the list of macros.

Accessing the Notes Option

PRESS



To access the notes screen, *press* the NOTE key.

The following screen will then appear.

NOTES		27 °C	USE MACRO
Note:	Railway Line		USE LIST
#	Macros		FUNC EDIT
1	Base Line		CANCEL
2	Bog (swamp)		RECORD
3	Visible Clay		
4	Hydro Line		
5	Railway Line		
Sel: ↑↓		Ch9: Alpha, ↔	20%

Note that the items in the Macros list are only filled in after you define and select your own macros. Information about macros is provided later in this section.

Note:



Please be aware that the note stored in your data file will be the one indicated in the data field beside the NOTE parameter field, as illustrated below.

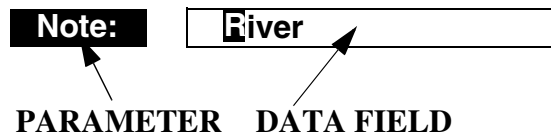

You can enter and record a note in your data file at any time.

Recording Notes using a Pre-Defined List

In the Notes screen, *press* the up or down arrow keys to bring the cursor to the Note field.

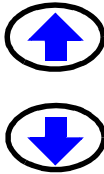

PRESS



Press the F2 <USE LIST> key to access the pre-defined list of notes.

The following screen will then appear.

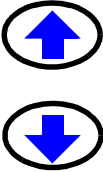
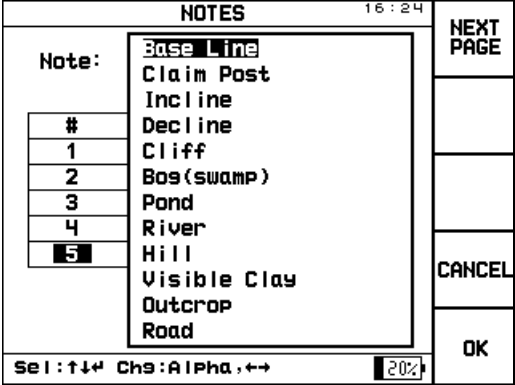

Press the up or down arrow keys to bring the cursor to the feature you want to choose. It will then be highlighted.

PRESS



If the note you want to choose is not on the present list, *press* the F1 <NEXT PAGE> key to see more entries.

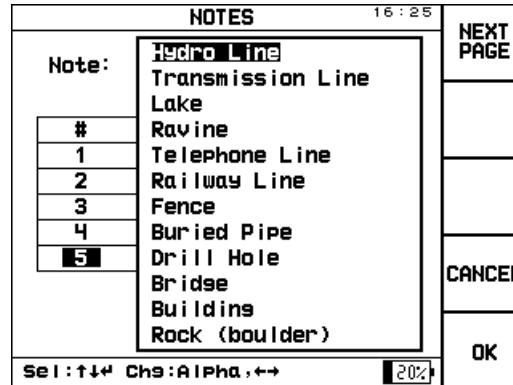

PRESS



To cancel this function, *press* the F4 <CANCEL> key. This will return you to the notes screen.

PRESS



When you are satisfied with the selected note, *press* the F5 <OK> key. It will now be inserted in the note parameter field.

PRESS



To record this note in your data file, *press* the F5 <RECORD> key. The note parameter field will then be cleared and ready for the next note recording.

Recording Notes Using Macros

What is a macro?

A macro is a note that you want to reuse. It can be one of the notes taken from the list or it can be any arbitrary string of characters.

Defining your five macros—

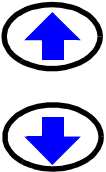

In the notes screen, *press* the up or down arrow keys to bring the cursor to the first macro entry, as illustrated below.

NOTES		USE MACRO
Note: <input type="text"/>		USE LIST
#	Macros	FUNCT EDIT
1		CANCEL
2		RECORD
3		
4		
5		
Sel: ↑↓ Ch9: Alpha, ↔		

Operations

You can enter each macro by either using the pre-defined list (by pressing the F2 <USE LIST>key as described in the previous section or by manually entering the string of characters as explained below.



Press the F3 <FUNCT/EDIT> key to choose the EDIT mode.

Enter the note, as an alphanumeric value up to 19 characters long. If you are unsure of the procedure, please see “Entering Alphanumerics, Example 2” on page 1-26.

PRESS



Once the entered macro is correct, *press* the F3 <FUNCT/EDIT> key to exit the EDIT mode.

In the following illustration, the five chosen macros are a combination of pre-defined notes and manually entered notes.

NOTES		USE MACRO
Note:	<input type="text"/>	
#	Macros	USE LIST
1	Base Line	
2	Drill Collar	
3	Pond	FUNCT
4	Walkabout Creek	EDIT
5	Telephone Line	CANCEL
Sel : ↑↓↔ Ch9 : Alpha , ↔		RECORD



Note:

Macros can be edited or reentered at any time.

Using your macros—

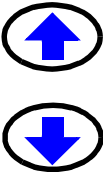

In the notes screen, *press* the up or down arrow keys to bring the cursor to the macro you wish to enter in the note parameter field. For instance if you wish to use macro #5, then the number 5 will be highlighted as illustrated below.

NOTES		USE MACRO
Note:	<input type="text"/>	USE LIST
#	Macros	FUNC EDIT
1	Base Line	CANCEL
2	Drill Collar	
3	Pond	
4	Walkabout Creek	
5	Telephone Line	
Sel : ↑↓← Chs : Alpha , ↔		RECORD

PRESS



Press the F1 <USE MACRO> key to insert the chosen macro in the note parameter field. The screen will resemble the one illustrated below.

NOTES		USE MACRO
Note:	Telephone Line	USE LIST
#	Macros	FUNC EDIT
1	Base Line	CANCEL
2	Drill Collar	
3	Pond	
4	Walkabout Creek	
5	Telephone Line	
Sel : ↑↓← Chs : Alpha , ↔		RECORD

Operations

PRESS 

To record this feature in your data file, *press* the F5 <RECORD> key. The note parameter field will then be cleared and ready for the next note recording.

Recording Manually Entered Notes



In the notes screen, *press* the up or down arrow keys to bring the cursor to the note parameter field.

PRESS 

Press the F3 <FUNCT/EDIT> key to choose the EDIT mode.

Enter the note, as an alphanumeric value up to 19 characters long. If you are unsure of the procedure, please see Chapter 1, “Getting Started” and the “Alphanumeric Entry, Example 2” topic on page 1-26.

PRESS 

Once the entered note is correct, *press* the F3 <FUNCT/EDIT> key to exit the EDIT mode.

PRESS 

To record this note in your data file, *press* the F5 <RECORD> key. The note parameter field will then be cleared and ready for the next note recording.

Recalling Data

During the course of your measurements, you may want to recall any stored data, regardless of when it was stored.

Working with Stored Data

When the Autograv records a measurement, all information associated with that measurement (i.e. measured data, line and station numbers, notebook information, time and date) are filed together in a single record.

The Autograv provides a variety of capabilities for accessing this stored data.

Recalling Stored Data

PRESS



To access the recall screen, *press* the RECALL key. The following screen is displayed.

RECALL		16:34	SHOW SURVEY PARAMS
Survey:	Default		NEXT LINE
Line:	0.N		FUNCT EDIT
			PLOT LINE DATA
			RECALL LINE DATA
Sel: ↑↓ →		GoTo: FS, ←	20%

Operations

You can recall data sequentially from every file that was stored in memory.



Note:

A survey can contain as many measurements as you wish. Each measurement is identified with its unique identification number (ID) within a particular survey.

Scrolling Through Your Surveys

If you have more than one survey in your data file, you will be able to scroll through each survey in your data file. Each survey is stored sequentially in the order it was created.



Press the up or down arrow keys to bring the cursor to the Survey: field.

The word survey will then be highlighted as illustrated below.

Survey:

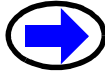
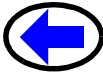

Press the right or left arrow key to toggle between surveys. The name of each survey is displayed in sequence.

PRESS



To display the survey parameters for a selected survey, *press* the F1 <SHOW SURVEY PARAMS> key. The following screen is displayed:

SHOW SURVEY PARAMETERS	
SurveyID:	a1
Customer:	
Operator:	
Longitude:	79.60E
Latitude:	43.90N
Azimuth:	0.0
Elevation:	0.00
UTM Zone:	0
GMT Diff.:	0.0
System:	NSEWmt
OK	

PRESS



Press the F5 <OK> key to exit this screen. The system returns you to the RECALL screen.

PRESS



To scroll through the lines in your surveys, *press* the F2 <NEXT LINE> key.

Plotting Line Data

PRESS



If you want to see a visual plot of your line data, *press* F4 <PLOT LINE DATA>. The following screen is displayed:

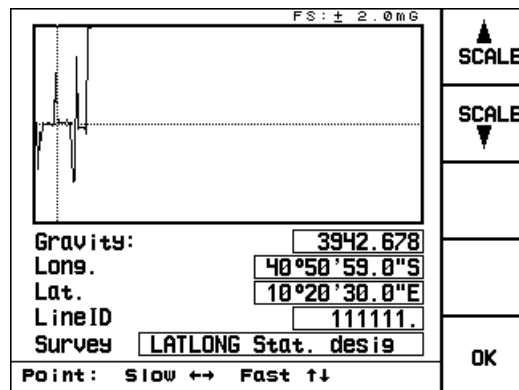

When you are finished looking at the plot, *press* the F5 <OK> key.

Recalling Line Data

PRESS



If you want to see a numeric plot of your line data, *press* the F5 <RECALL LINE DATA> key. The following screen is displayed:

AUTOGRAV RECALL DATA		RECALL NEXT POINT
ID	Data	
Grav.	2984.811	
S.D.	0.049	
TiltX	-0.611	
TiltY	-0.611	
Temp.	0.25	
E.T.C.	-0.086	
Dur.	64	
#Rej.	0 = 0.0%	
Time	19:18:41	
LineID	0.	
North.	200.S	OK
East.	100.E	

PRESS



When you are finished looking at the plot, *press* the F5 <OK> key.

Dumping Data

You can dump your data to a PC either through RS-232 cable or through your USB cable. We recommend that you dump your data every day.



Important:

If you are dumping data from your CG-5 for the first time, you must first install the Scintrex Utilities program supplied to you with your CG-5. You will not be able to transfer data from your CG-5 to your PC without having SCTUTIL installed in your PC. If you are unsure of this procedure, please see Appendix D, “Installing SCTUTIL” and “Installing SCTUTIL” on page D-2. Please note that Norton Antivirus software may disrupt your downloading process.

Dumping Data using the RS-232C Port

The process for dumping data via the RS-232C port is to:

- Connect the RS-232C cable from your CG-5 to your computer
- Start the SCTUTIL program
- Set communication parameters in the SCTUTIL program
- Set communications parameters on the CG-5
- Start the DUMP process on your CG-5
- Start the DUMP process in the SCTUTIL program

The system then transfers data from the CG-5 to your Personal Computer. You can also terminate data dumping at any time as required.



Important:

Carefully follow these steps.

**Note:**

Your version of SCTUTIL may have different version numbers from the ones shown in the following examples. However, the screens will appear the same and all functionality is the same as shown here.

Connecting the RS-232C Cable

This process consists of connecting your RS-232 cable to your PC and the COM1 port on the CG-5.

**Important:**

Make sure that your RS-232 cable is connected to the appropriate serial port on your PC. Most modern PCs have more than one serial port.

Starting the SCTUTIL Program for RS-232 Data Dumping

Install the SCTUTIL program provided on CD-ROM with your CG-5.

Double-click on the SCTUTIL icon to start the program.

Operating the CG-5 in the Field

The following screen is displayed:

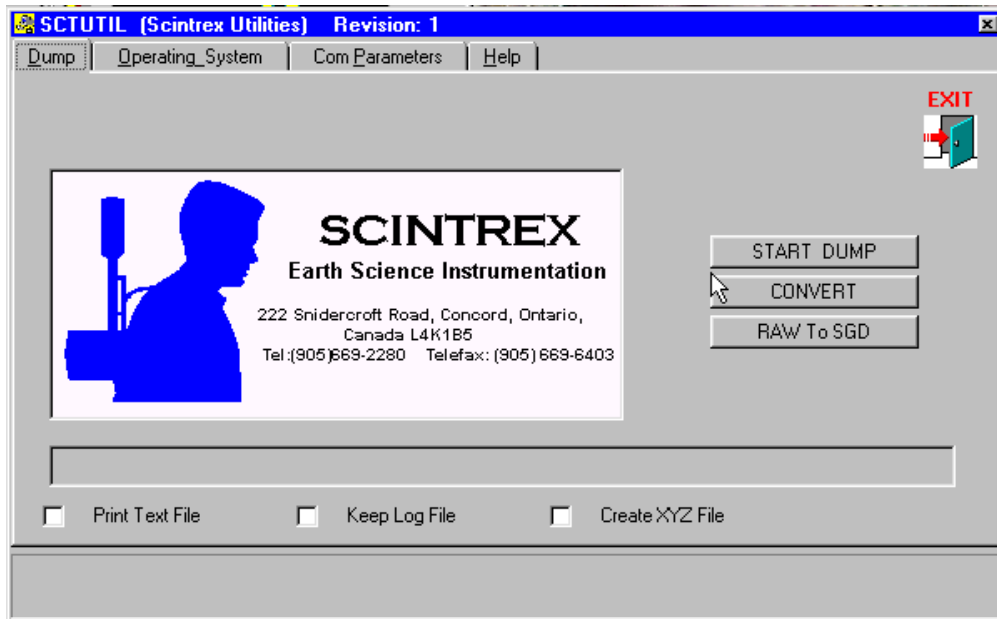

Note:

In the Dump window of the SCTUTIL program, you can enable **Keep Log File**, this will produce a complete log of all the surveys as well as assist the Customer Service personnel in helping you trouble-shoot. The log file contains all the settings of your CG-5. Other files that are produced, whose data format is also illustrated, are the following:

- *.raw: The raw data file. This is in binary format and cannot be opened by the user.
- *.log: The log file. This is a text file and can be opened using NOTEPAD.EXE or WORDPAD.EXE.

- *.sgd. The Scintrex Geophysical Data Format file. This is your dump file that can be used with many applications. It is a binary file.

```

P2 1103Dec052002.log
[ *** File Header Record *** ]
FILE INDEX      0
Record ID       1008
Record length   112
Manufacture Name SCINTREX LTD.
Manufacture ID  815
Family ID       8000
Instrument Model 0

P2 1103Dec052002.raw
000000 10 08 00 70 53 43 49 4E 54 52 45 58 20 4C 54 44 ...pSCINTREX LTD
000010 2E 00 00 00 08 15 80 00 00 00 00 00 43 47 2D 35 .....CG-5
000020 00 00 00 00 00 00 00 00 00 00 00 00 FF FF 00 00 .....
000030 00 00 00 00 00 00 00 00 00 00 00 00 00 00 00 00 .....
000040 00 00 00 00 00 00 00 00 00 00 00 00 00 00 00 00 .....
000050 00 01 00 00 03 D1 66 D8 27 11 07 D2 00 00 FF FF .....f.....
000060 FF FF FF FF FF FF FF FF FF FF FF FF FF FF FF FF .....fault.....
000070 10 04 00 B8 00 00 66 61 75 6C 74 00 00 00 00 00 .....
000080 00 00 00 00 00 00 00 00 00 00 00 00 00 00 00 00 .....
000090 00 00 00 00 00 00 00 00 70 32 00 00 75 6C 74 00 .....p2..ult.
0000a0 00 00 00 00 00 00 00 00 00 00 00 00 00 00 00 00 .....

P2 1103Dec052002.sgd
000000 08 10 70 00 53 43 49 4E 54 52 45 58 20 4C 54 44 ...p SCINTREX LTD
000010 2E 00 00 00 15 08 00 80 00 00 00 00 43 47 2D 35 .....CG-5
000020 00 00 00 00 00 00 00 00 00 00 00 00 FF FF 00 00 .....
000030 00 00 00 00 00 00 00 00 00 00 00 00 00 00 00 00 .....
000040 00 00 00 00 00 00 00 00 00 00 00 00 00 00 00 00 .....
000050 01 00 00 00 D8 66 D1 03 27 11 D2 07 00 00 FF FF .....f.....
000060 FF FF FF FF FF FF FF FF FF FF FF FF FF FF FF FF .....fault.....
000070 04 10 B8 00 00 66 61 75 6C 74 00 00 00 00 00 00 .....
000080 00 00 00 00 00 00 00 00 00 00 00 00 00 00 00 00 .....
000090 00 00 00 00 00 00 00 00 70 32 00 00 75 6C 74 00 .....p2..ult.
    
```

- *.txt: The text version of your dump file. The Altitude column contains the ambient temperature values if the ambient temperature is selected in the Options Screen. The ‘Decimal Time +date’ column is meant for convenient plotting of time series data and should not be used if an accurate time record is required. It can viewed with either Microsoft NOTEPAD.EXE or WORDPAD.EXE application.
- *.xyz: same as *.txt except the header information is removed for easier processing

Operating the CG-5 in the Field

- *.smp: contains the raw unprocessed samples recorded at 6 Hz from the gravity, TiltX, TiltY and temperature sensors.

```

P2 1103Dec052002.smp
287841002 33419 31827 312670094
287849067 33420 31825 312670051
287835824 33424 31825 312670070
287839306 33419 31830 312671768
287840451 33415 31827 312671606
287829084 33421 31823 312671537
287828092 33419 31829 312671088
287831259 33419 31829 312669999
287837706 33420 31825 312670850

P2 1103Dec052002.txt
Terrain Corr: NO
Seismic Filter: YES
Raw Data: YES
Line 44.000N
LINE STATION ALT GRAV SD TILT X TILT Y TEMP TIDE DUR REJ TIME DEC TIME+DATE TERRAIN
26.416 82.394 0.00 4342.129 0.058 0.7 -0.2 82.39 -0.036 60 0 17:49:25 1246.74146 0.000
26.416 82.394 0.00 4342.126 0.061 0.9 -0.5 82.39 -0.036 60 0 17:50:33 1246.74225 0.000
26.416 82.393 0.00 4342.126 0.062 1.3 -0.5 82.39 -0.035 60 0 17:51:37 1246.74299 0.000
26.416 82.391 0.00 4342.128 0.050 1.4 -0.6 82.39 -0.035 60 0 17:52:41 1246.74373 0.000
26.417 82.393 0.00 4342.127 0.059 1.7 -0.5 82.39 -0.035 60 0 17:53:45 1246.74447 0.000

P2 1103Dec052002.xyz
0.00 4342.129 0.058 0.7 -0.2 82.39 -0.036 60 0 17:49:25 1246.74146 0.000
0.00 4342.126 0.061 0.9 -0.5 82.39 -0.036 60 0 17:50:33 1246.74225 0.000
0.00 4342.126 0.062 1.3 -0.5 82.39 -0.035 60 0 17:51:37 1246.74299 0.000
0.00 4342.128 0.050 1.4 -0.6 82.39 -0.035 60 0 17:52:41 1246.74373 0.000
0.00 4342.127 0.059 1.7 -0.5 82.39 -0.035 60 0 17:53:45 1246.74447 0.000
0.00 4342.128 0.041 1.9 -0.3 82.39 -0.034 60 0 17:54:49 1246.74521 0.000
0.00 4342.126 0.050 2.0 -0.2 82.39 -0.034 60 0 17:55:53 1246.74595 0.000
0.00 4342.129 0.052 2.1 -0.2 82.39 -0.034 60 0 17:56:57 1246.74669 0.000
0.00 4342.126 0.052 2.1 -0.1 82.38 -0.034 60 0 17:58:01 1246.74742 0.000
  
```

The *.smp data file contains the analog data output values of the gravity sensor, x tilt sensor, y tilt sensor and the temperature sensor. The following formulas can be applied to obtain, respectively, the gravity, the x tilt, the y tilt and the temperature compensation factor values.

column 1 Gravity

$$\text{Gravity} = \text{GCAL1} * \text{grav_sample} / 536870912$$

Note:



536870912 is a Full scale of the 24-bit A/D converter with 5 additional bits. The grav_sample value is obtained from column 1 of the *.smp data file.

column 2 Tilt X

$$\text{TiltX} = ((\text{TILTX_Sample} - \text{TILTX_OFFSET}) * 0.000076295 - 2.5) * \text{TILTX_SENSITIVITY}$$

The TILTX_OFFSET parameter is expressed in arcsecond, and the TILT_SENSITIVITY parameter is expressed in arcsec/V. These are parameters of your CG-5. Please refer to “Specifying Instrument Parameters” on page 2-14, for the values specific to your instrument.

The TILTX_Sample is obtained from column 2 of the *.smp data file.

column 3 Tilt Y

$$\text{TiltY} = (-1) * ((\text{TILTY_Sample} - \text{TILTY_OFFSET}) * 0.000076295 - 2.5) * \text{TILTY_SENSITIVITY}$$

The TILTY_OFFSET parameter is expressed in arcsecond, and the TILTY_SENSITIVITY parameter is expressed in arcsec/V. These are parameters of your CG-5. Please refer to “Specifying Instrument Parameters” on page 2-14, for the values specific to your instrument.

The TILTY_Sample is obtained from column 3 of the *.smp data file.

column 4 Temperature

$$\text{Temp} = (\text{TEMP_Sample} * \text{TEMP_SF}) - \text{TBIAS} - \text{TOFFSET}$$

Where TBIAS= 500 millidegrees,
and TEMP_SF=1000/536870912.=(1 deg full range)



Note:

The TEOFF parameter is specific to each CG-5 unit. Please contact Scintrex for the TEOFF value for your CG-5.

The TEMP_Sample is obtained from column 4 of the *.smp data file.



Note:

The *.smp file is empty (size= 0 bytes) if “Save Raw Data” has been disabled. Please refer to “Specifying Corrections and Filters” on page 2-11 for an explanation of the Save Raw Data parameter.

Setting Communication Parameters in the SCTUTIL Program

Before you can transfer data or upload the most recent version of CG-5 operating software, you must set the proper baud rate as well as the correct number of data bits in the SCTUTIL program.

Click on the Com Parameters window to set the communication parameters.

The following screen will then appear.

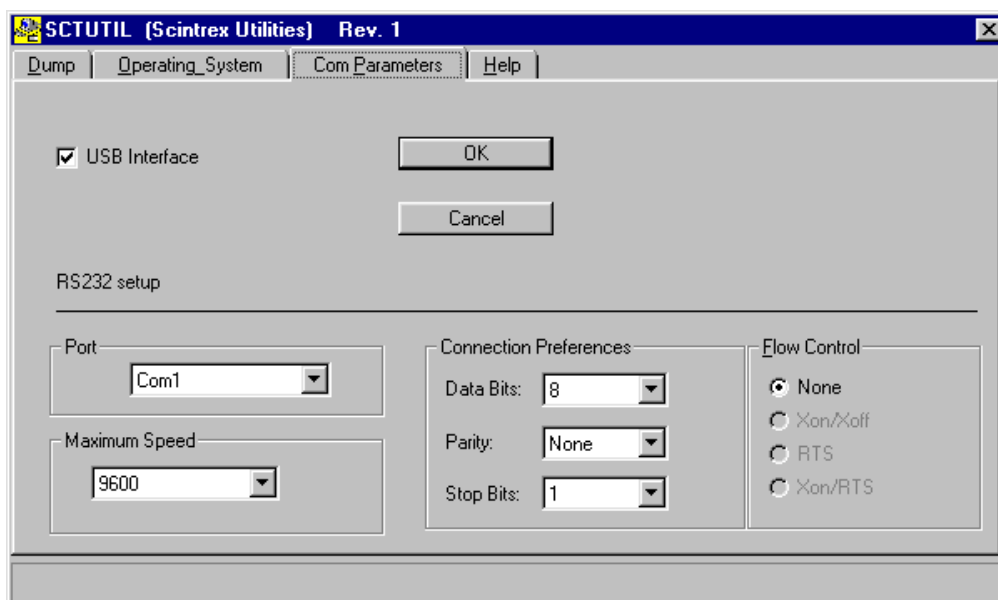

Click on USB interface to disable it. The default setting for the CG-5 is USB enabled.

Select the desired baud rate, number of data bits, stop bits and parity, the default values are 19200,8,1 and n.



Important:

Your baud rate, data bits and stop bits have to be the same on your CG-5 and your PC. Furthermore the data bits, parity and stop bit are fixed on your CG-5, you can never change these. You need only to set the com port and the baud rate.

Select flow control. Chose either “none” or Xon / Xoff depending on what works for your system.

To select your com port, **click** on the down arrow located beside the com1 selection.

The following screen will then appear:

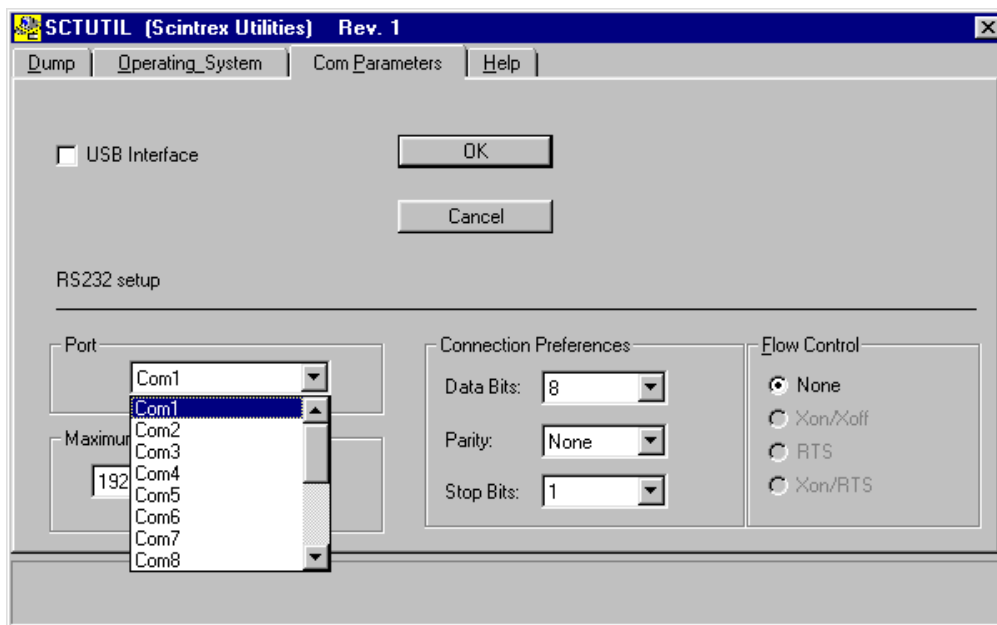

Select the desired com port. In most cases, this will be com1.

Setting Communication Parameters in the CG-5

To set these parameters, you must first access the DUMP screen on your CG-5.

Press the SETUP key. In the SETUP menu, select the DUMP icon. The following screen is displayed:

DUMP PARAMETER SETUP		
Baud rate:	<input type="text" value="9600"/>	START DUMP
Data bits:	8	
Parity check:	NO	
Stop bits:	1	FUNCT
Data format:	BINARY	EDIT
Chs : ↔		OK



Note:

You can only modify the baud rate, the other dump parameters cannot be modified, they are illustrated only as a reference in order to set your PC serial port accordingly.

PRESS



Press the F3 <FUNCT/EDIT> key to choose the EDIT mode.

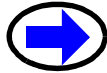
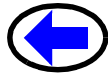

Press the right or left arrow key to select the baud rate at which you want to transfer your data.

Starting the CG-5 Dump Process

PRESS



Press the F1 <START DUMP> key on the CG-5 to initiate a data dump; a message indicating that the data is being transferred will appear in the lower left hand corner of the console screen.



Note:

To abort the dump process while the data is being transferred, *press* the F1 <STOP DUMP> key.

Starting the SCTUTIL Dump Process

On your PC, in the Dump window of the SCTUTIL program, *click* on START DUMP. This is the last step required to start data transfer to your PC.

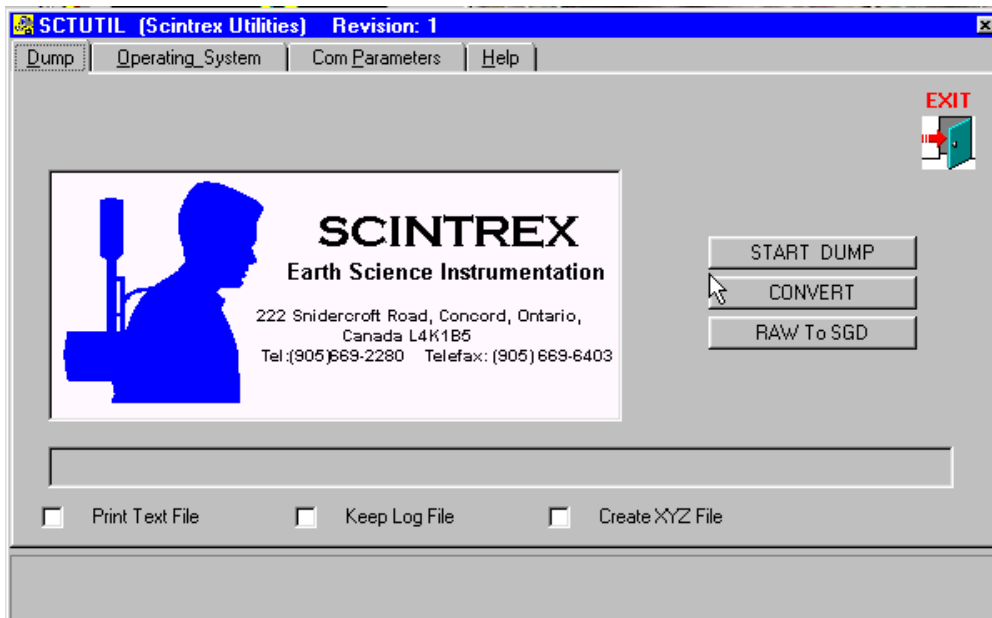

You will then be prompted to choose a file name for your data, as per the screen illustrated below:

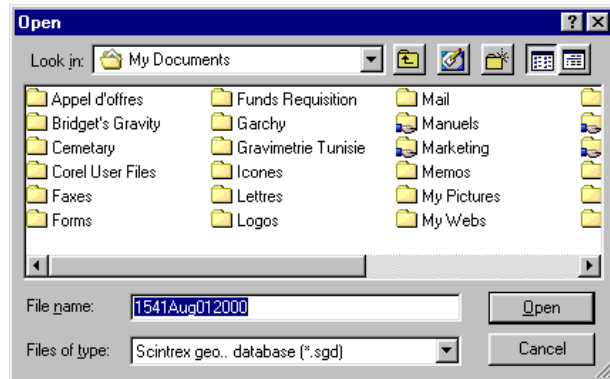

Note:

The default name of your file follows the following format: time (24 HRS) minutes month date year. The CG-5 will dump in Scintrex Geophysical Database format. Please see below for a definition of the *.SGD format.

Click on the Open button. You will then notice the “ON-LINE” message appears and that the data is being transferred, and a bar graph shows the progress of the transfer process. After the data is successfully transferred, a message indicating successful data transfer will appear in the lower left-hand portion of your CG-5 screen as shown below:

Operating the CG-5 in the Field

DUMP PARAMETER SETUP	
Baud rate:	9600
Data bits:	8
Parity check:	NO
Stop bits:	1
Data format:	BINARY
Data transfer finished!	
START DUMP	
FUNCT EDIT	
OK	

Once the data is successfully transferred, a message indicating successful upload of your data will appear on your PC as follows:

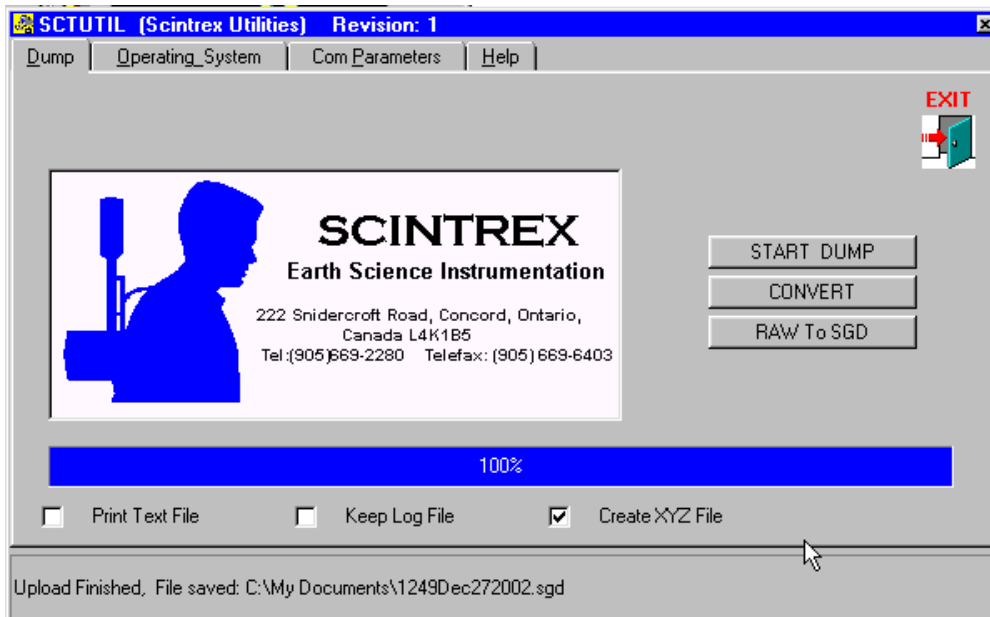

To finalize the dump process click on the CONVERT button. Depending on your selection of check boxes below the progress bar the CONVERT process will produce several files.

PRESS

After you have transferred your data to your PC, *press* the F5 <OK> key on your CG-5 to return to the previous screen.

Converting Raw Data to SGD

SGD is the Scintrex Geophysical Database format that is a standard format for all Scintrex instruments. If you are working with Geosoft, for example, you may want to use this format to import directly into your processing software.

If you want to use this process, *press* the RAW to SGD button in SCTUTIL.

Dumping Data Through a USB Port

When you dump data using the USB port, you are not required to set any parameters on your CG-5 unit. This differs from the RS-232C setup, which requires you to access the DUMP menu on the Autograv.

Minimum System Requirements

In order for you to transfer data from your CG-5 using the USB mode, you must have the following in your PC:

- USB port
- USB host driver

We strongly recommend that you install your USB host driver immediately, before attempting to dump the data from your CG-5 to your PC. For information on installing your USB driver, see “Installing your USB driver” on page D-9.



Important:

The SCTUTIL Scintrex Utilities program **will not function in a Windows 3.x or Windows 95 environment.**

The Minimum requirements for your PC are as follows:

- **WINDOWS 98 or XP Professional**
- **8 MB of RAM**
- **3 MB of Hard Disk space**

Dumping Data with the USB Port

In the Com Parameters window of the SCTUTIL program, make sure that USB Interface is enabled. To enable this interface click on the USB window, as illustrated below:

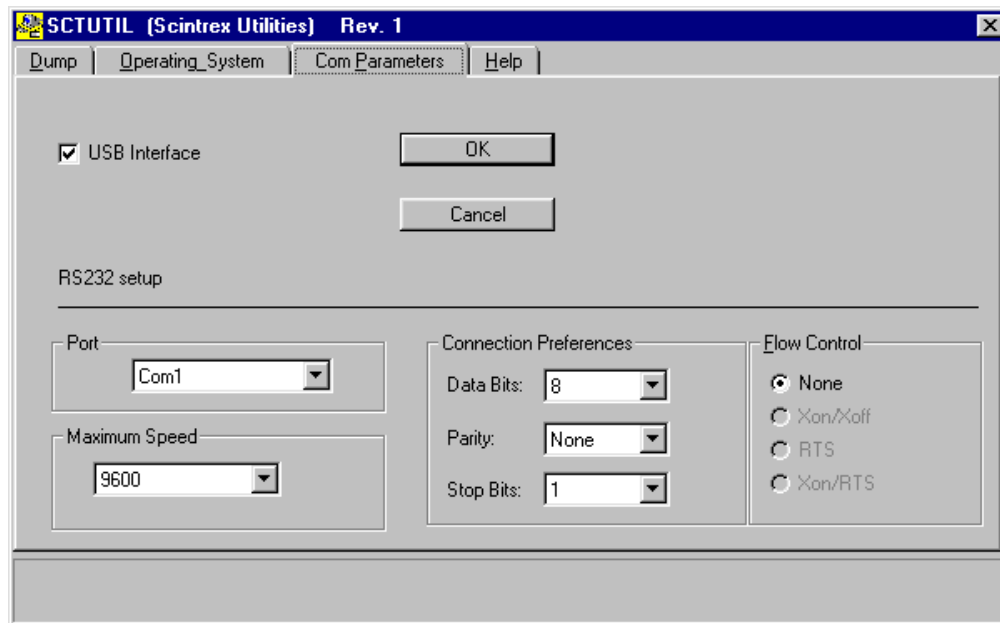

Follow this sequence of steps:

Power up your CG-5 by pressing the ON key.

Connect your USB cable to the your PC.

Connect your USB cable to your CG-5.



Note:

If this is the first time that you are dumping through the USB port, your PC will recognize the new hardware and prompt you through the installation of

the USB driver. Your CG-5 USB driver is located on the SCTUTIL CD-ROM. If this is not the case or you are unsure of this procedure, please see “Installing your USB driver” on page D-9.



Note:

In the Dump window of the SCTUTIL program, you can enable **Keep Log File**, this will produce a complete log of all the surveys. Our Customer Service personnel may require these files to help you trouble-shoot your system.

Select the file format that you would like the utility to produce upon download. Other files that are produced are the following:

- *.raw: The raw data file. This is in binary format that is viewable but is not in user friendly format.
- *.log: The log file. This is a text file and can be opened using Microsoft NOTEPAD.EXE or WORDPAD.EXE applications. The log file contains all the settings of your CG-5.
- *.sgd. The Scintrex Geophysical Data Format file. This is your dump file that can be used with many applications such as Geosoft's Oasis montaj. It is a binary file.
- *.txt: The text version of your dump file. The Altitude column contains the ambient temperature values if the ambient temperature is selected in the Options Screen. The 'Decimal Time +date' column is meant for convenient plotting of time series data and should not be used if an accurate time record is required. It can be viewed with either Microsoft NOTEPAD.EXE or WORDPAD.EXE applications.
- *.xyz: same as *.txt except the header information is removed for easier processing.

In the Dump window of the SCTUTIL program, *click* on START DUMP to initiate the data transfer to your PC.

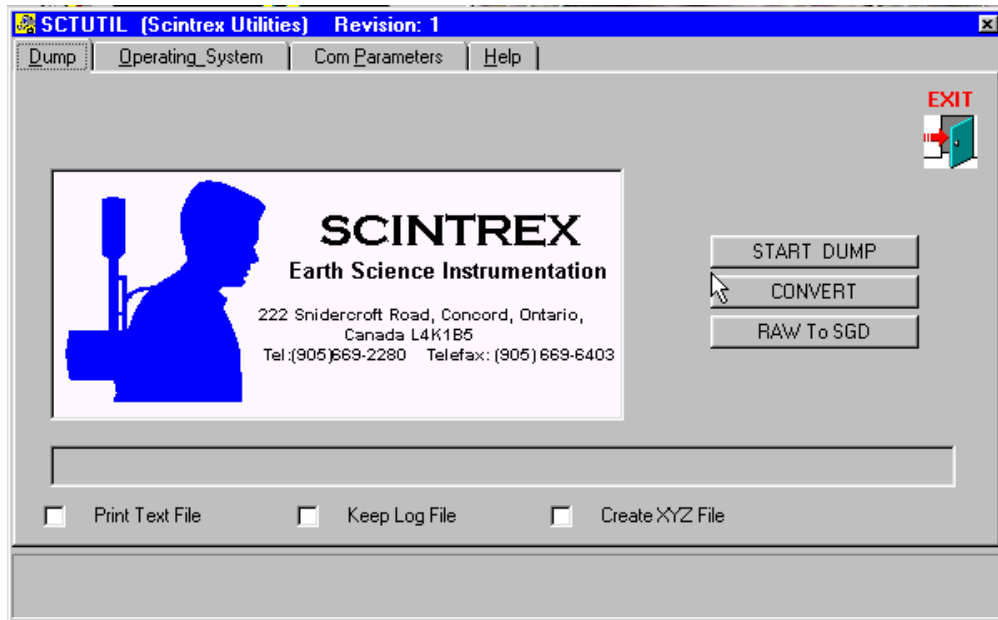

You will then be prompted to choose a file name for your data, as per the screen illustrated below:

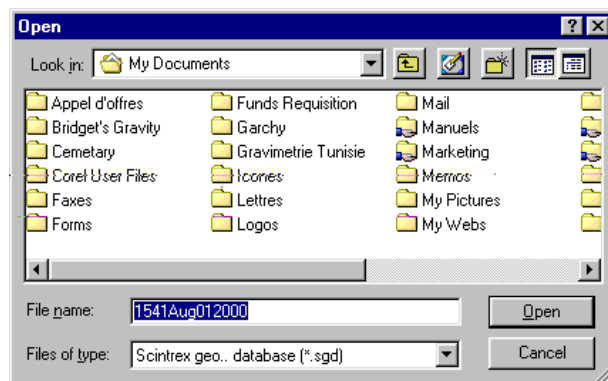



Note:

The default name of your file follows the following format: time (24 HRS) minutes month date year. The CG-5 will dump in Scintrex Geophysical Database format. This format is compatible with all modern gravity programs.

Click on the Open button. You will then notice the “ON-LINE” message appears and that the data is being transferred and a bar graph shows the progress of the transfer process. After the data is successfully transferred, a message indicating successful data transfer will appear in the lower left-hand portion of your CG-5 screen.

Once the data is successfully transferred, a message indicating successful upload of your data will appear. *Click* on OK to close your data file.

To finalize the dump procedure click on the convert button as described in the RS232 dumping procedure, on page 3-50.

PRESS



Once you have transferred your data to your PC, *press* the F5 <OK> key on your CG-5 to return to the previous screen.

Reprogramming your CG-5

From time to time a new version of the CG-5 operating software (OS) will become available. You may be receiving software upgrade notifications for your CG-5. You can easily upload the most current version of the CG-5 operating software by using SCTUTIL. The most recent version of the CG-5 OS is available on our company website.



Note:

The upgrading of your software version can be done either with the RS-232 or USB ports. However, the USB port upgrade is much faster and uses less menus.



Note:

If you are unsure of the current software version, *press* the INFO/7/STU key. The software version will be indicated on the first line of this screen.



Important:

Before you upgrade your software to the newest version, you must dump all data. This data will be erased once you upgrade your software.

PRESS



Press the ON / OFF key.

Connect your USB or RS-232 cable to your PC and your CG-5.

Operating the CG-5 in the Field

Start your SCTUTIL program and *click* on the operating system window, the following window will appear.

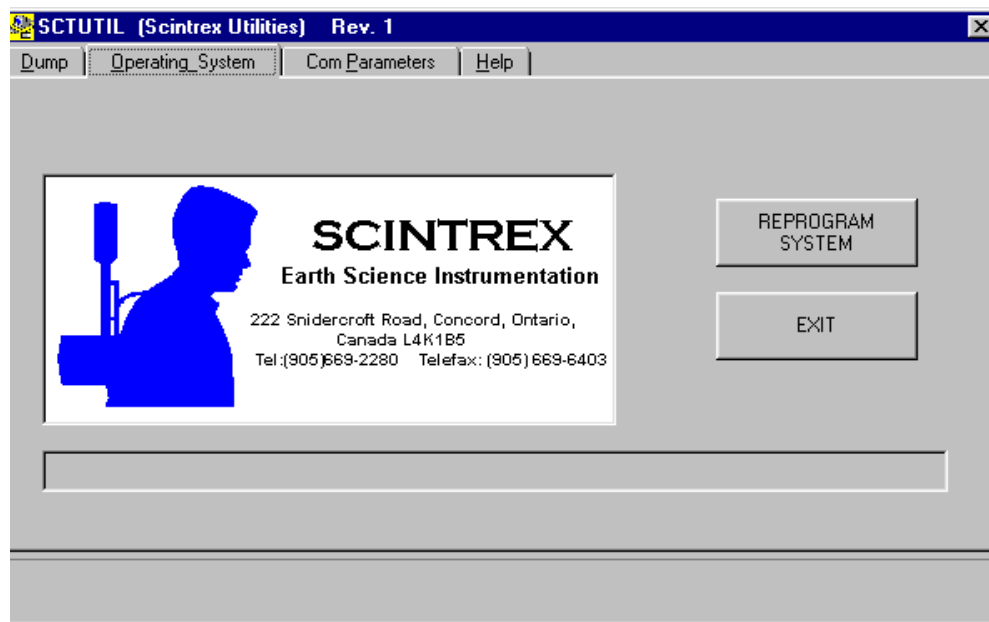

Click on REPROGRAM SYSTEM.

The following window will appear.

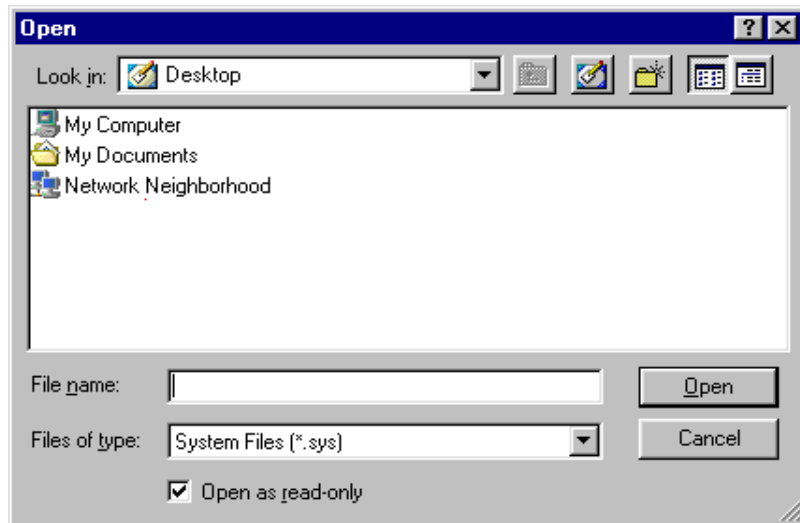

You will then **browse** for the CG-5 system (*.sys) files sent to you by Scintrex.

Once you have found it, **click** Open.

If you are using your USB cable, the upgrade will then start and should be completed in a very short time.

If you are using an RS-232 cable instead, proceed to “Installing your USB driver” on page D-9.

Using the RS-232 Cable to Upgrade



Press the SETUP key. The following screen is displayed.

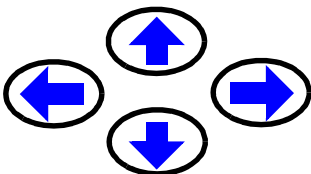
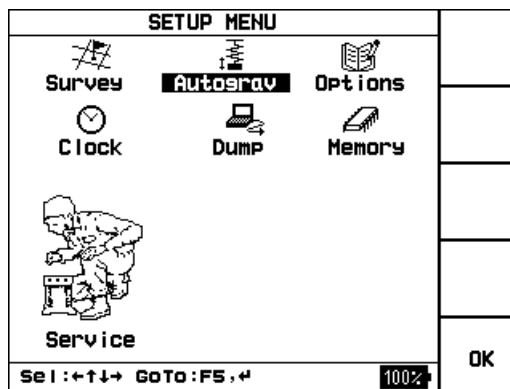

Press the arrow keys to bring the cursor to the service icon.

The word Service is highlighted, as illustrated below.

Service



Press the F5 <or ENTER> key. The following screen is displayed.

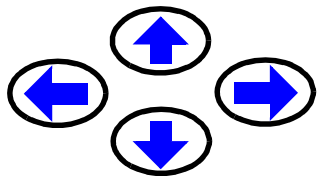
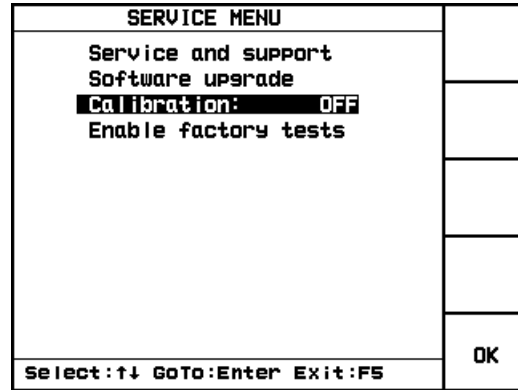

Press the arrow keys to bring the cursor to the software upgrade menu.

The phrase “software upgrade” will then be highlighted, as illustrated below.

Software upgrade

Operations

PRESS



Press the ENTER key.

You will then be prompted to do one of the following:

PRESS



To cancel this operation, *press* the F1 <CANCEL> key,

OR

or

PRESS



to continue, *press* the ENTER key.

The following message will then appear on the CG-5 screen.

REPROGRAMMING OPERATING SYSTEM

Once, the message has disappeared, the reprogramming of your CG-5 is complete.

Note:



The SCTUTIL program will also indicate that the reprogramming is proceeding. Please wait that the CG-5 powers down for the reprogramming to be complete. When the CG-5 is powered up an hourglass will appear for five seconds.

Note:



Please cold boot at this point.

Clearing Memory

You can clear the CG-5 flash memory whenever required.



Important:

All stored data will be erased, however instrument constants will not be affected as they are stored in a separate memory.

PRESS



To access the Memory Clear screen, select the MEMORY option in the main Setup Screen and *press* the F5 <OK> key. The following screen will then appear:

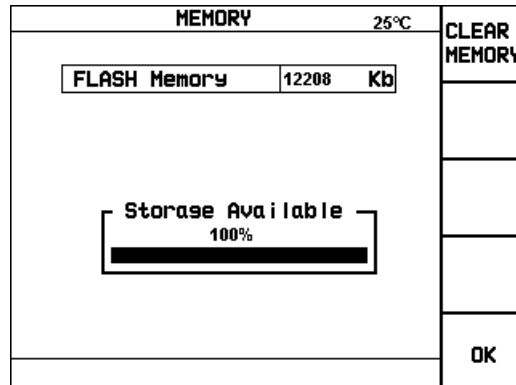

Operations

The total amount of available memory in your flash drive is illustrated. Furthermore, the storage available shows the percentage of this space that is still available.

Operating the CG-5 in the Field

To clear the memory, *press* the following hot keys in this sequence: F1, F3, F2 and F4.

PRESS



While the memory is being erased, the message “Memory clearing” will appear where the “Storage Available” message was. The unit will beep when you have cleared the memory.

PRESS



Press the F5 <OK> key to exit this screen.

4

Optimizing your Field Operations

In order to operate your CG-5 effectively, you should be aware of additional tips specifically related to:

- Operating tips
- Transporting and handling
- Minimizing motion noise
- Minimizing wind noise
- Selecting base stations
- Operating in cold weather
- Using the CG-5 before warm-up stabilization is complete

This chapter provides additional details on these topics.

Tips for Better Results

The following are some hints for better instrument results:

- Whenever the CG-5 is not being actively transported between stations by hand, vehicle or aircraft, even for 15 minutes or less, place it on its tripod and level it, within the range of the tilt meters until you are ready to make a measurement. This is especially important for microgravity.

Similarly the CG-5 should be leveled on its tripod overnight and whenever it is not on survey to minimize hysteresis effects as reviewed in Appendix C. If the Autograv has been left *off-level* at rest for some hours or more, it should be set up onto the tripod and left leveled for several hours (e.g. overnight) to stabilize before taking a measurement.

- When necessary to replace the battery during the course of a long day, then take a reading with the original battery, replace the original battery, wait 5 to 10 minutes, and then repeat the previous reading. This will help determine if there has been a level shift (however small).
- Ensure that you have recently updated the drift correction and adjustment as described in “Applying Drift Corrections” on page 5-10.
- Follow the same setup and reading routine at each station. For example, if you are transporting the Autograv by vehicle, take each reading at approximately the same interval after the vehicle has stopped.
- Where it is possible, select station locations that are on solid ground and away from trees, bridges, poles or other potential sources of vibration.

Transporting and Handling

The Autograv case is waterproof and the instrument is designed to be transported between stations without the dust cover. The cover only needs to be installed when the instrument is being shipped or when there is a danger of the front panel or control console being damaged.

To get the best results from your Autograv and ensure a long working life, treat your instrument carefully. We recommend:

- Avoiding shocks and jolts caused by hitting the instrument against rocks and trees, etc. when taking the instrument out of vehicles and placing it on the tripod.
- When transporting the instrument in a vehicle, place it on a compliant surface, either a padded seat or a pad made from other shock absorbing

material and fasten it down with a flexible binding material (e.g. seat belt or rubber-based cord).

- The CG-5 is an extremely sensitive and precise scientific instrument. It is capable of measuring gravity changes that would result in a 10^{-10} metres change in the proof mass vertical position. Note that the hydrogen atom has a diameter of the same size. However, it is inherently robust and well capable of providing accurate relative gravity values under relatively rough (but normal) field handling.

In a controlled shock test, one meter was dropped from various heights to a hard floor. The drops from 40mm, resulting in a 20g peak deceleration at the sensor location, resulted in level shifts of less than 0.01 mGal. The shock isolators and the stops limiting the proof mass movement reduce the effect of shocks on the sensor. Nevertheless, *the meter does have limits*, so that careful handling during measurement generally yields better results.

- To obtain the highest accuracy after unavoidable rough transport, allow the Autograv to settle for a few minutes after being leveled on its tripod before starting a reading. If rough handling has occurred, there may be a slight (but noticeable) drift for only a few minutes after leveling.
- Whereas the CG-5 may be placed in any orientation (tilted on its side) without damage, it is preferable to keep it upright in storage or during shipment. When at rest, it should be kept leveled (see above) for best results. If for some unavoidable reason, these precautions have not been followed, then allow time for the CG-5 readings to stabilize at the first station. By observing the sequential readings (e.g. 60 or 120 seconds averaging), you can tell if the unit is stable by evaluating their convergence.

Minimizing Motion Noise

Motion of the base of support of the meter may induce noise and reading errors. Such motion may be caused (and minimized) by:

Poor ground conditions - Soft ground, tree root movement and settling of the tripod. These are improved by the *Tilt Correction* (continuous or not). For more information, see Appendix B, "Theory of Operation".

Microseismic noise - This is due to the motion of the continental crust as an effective wave guide for seismic surface waves of (usually) a 4 to 8 second period. These effects may be caused by long-period ocean wave striking coast lines. They are most severe in islands in the seas (e.g. Ireland) but may

Optimizing your Field Operations

at times be troublesome even in the centre of large continents. These effects are improved by selection of the Seismic Filter. For more information, see Appendix B, “Theory of Operation”.

Earthquake shock waves - The shock waves from an earthquake may affect measurements so much that they cannot be carried on while the shock waves last. The effect of smaller tremors could be quite effectively reduced by selection of the Seismic Filter.

Industrial traffic noise - Vibration due to industrial activity and/or the nearby movement of heavy vehicles generally introduces higher frequency seismic noise (e.g. 4 to 100Hz). Gravity stations that are near such sources of noise should be avoided. Where they cannot be moved to a quieter location, measure longer (e.g. 120 seconds instead of 60 seconds).

The standard deviation of 1 second measurement samples is a good indication of the seismic noise, especially longer period microseismic noise. During quiet periods, SD is in the range of 0.010 to 0.030 mGal, whereas, during storms on open seas, it could increase to 0.150 mGal (measured in Toronto) or even higher near the sea coast. It could go to 0.5 mGal and higher during remote but strong earthquakes. The shorter period industrial noise is reduced by signal averaging over 1 second so that 1 second samples are less responsive to this noise. Noise spikes are removed by auto rejection of 1 second samples.

Minimizing Wind Noise

Wind striking a gravity meter can cause both vibration noise and reduction in gravity by tilting the meter out of verticality. Tilting the meter so that it is not vertical tends to reduce the apparent gravity value, despite the statistical averaging of the gravity measurements and the automatic tilt correction.

A windbreak should be devised to protect the meter from the effect of wind. A simple windbreak can be made from a sheet of canvas about 1.5m square, fastened on each of two opposing sides to two aluminum tubes or wooden rods (each, about 2m or 6.5ft long). The operator (or a helper) then holds the rods outstretched and vertical on the upwind side of the gravity meter to shield it from the wind. Alternately, a large (golf) umbrella could also be used.

The effect of wind noise may also be reduced by selecting the **Seismic Filter**. For details, see Appendix B, “Theory of Operation.”

Selecting Base Stations

Repeated gravity measurements at a base station can be used to determine the residual drift. In any survey area, try to select base stations that:

- are easily accessible to the other stations to be surveyed (e.g. perhaps near the centre of the survey area)
- have low vibration noise (e.g. away from industrial, vehicular or natural vibration sources such as rivers, beaches, volcanoes, etc.)
- have a hard, level surface where the precise tripod location may be repeated, and the level of the gravity meter maintained.

Operating in Cold Weather

In extremely cold weather (e.g. well below 0°C), the battery life will be reduced because of:

- increased battery drain required to maintain the temperature of the sensor and to heat the display
- reduced capacity of the battery because the battery becomes cold

An external battery belt and extender cable (optional) can reduce the effect of a cold battery as the external battery is kept warm by the heat of the operator. For more information, see “Using the Battery and Power Adapter” on page 5-1.



Note:

If desired, the external battery may be disconnected before measurement only so that there will be no interconnecting cable during measurement time.

Using the CG-5 Before Warm-Up Stabilization is Complete

After the CG-5 has been powered down for more than 2 days, it is recommended that the unit go through a warm-up period of 48 hours followed by the drift correction period which takes another 12 hours. In some situations, it may not be possible to wait this long before a survey is started.

Optimizing your Field Operations

After a 12-hour period, the instrument operates properly, except that the long-term drift will not be stable. Good results can usually be obtained after the 12-hour period, if you follow these steps:

1. Design the field survey such that there are frequent repeat readings at base station(s) and correct for drift in the data reduction. *Do not attempt to adjust the Drift constant in the CG-5 software yet.* For the first day of surveying, it is advisable to re-occupy base stations approximately once every two hours. On the second day, once every 4 hours is probably sufficient.
2. At the end of the second day's work, adjust the Drift Correction. After this, the instrument can be operated normally.

5

Maintaining Your CG-5 and Trouble-shooting

Using the Battery and Power Adapter

The CG-5 uses Smart battery technology. An on-board microprocessor automatically detects the charge on each of the two system batteries and software within the CG-5 converts these readings to actual time values. Therefore, you can reliably determine the amount of battery life available prior to going to the field or monitor the battery time left while working in the field.

The system provides several ways for determining the amount of battery time left:

- Battery icon on the lower right of the VGA display (i.e. CG-5 screen). This icon provides an indication of the battery capacity.
- Battery 1 time left and battery 2 time left indicators that can be accessed via the INFO key.

In the event that the combined capacity for both batteries drops below ten percent, the system also issues an alarm (i.e. buzzer signal) so that the operator can replace batteries before power is shut off.



Important:

The instrument must be powered at all times (even during storage)!

Powering the Instrument

The instrument must be powered at all times (even during storage) by either the internal 10.8 V battery or by an external power adapter. If a loss of power to the instrument occurs, the thermostat loses power and the instrument begins to cool down. The consequences of the power loss depends upon the length of time that the instrument is powered down.

Power Off Time	Stabilization Time Required After Power Up
a few minutes	30 minutes (approx.)
12 hours	24 hours (approx.)
48 hours or more	48 hours (approx.)

Using the Smart Battery

The CG-5 is shipped with two Li202S-66 11.1V lithium ion batteries produced by Emerging Power (USA). These batteries are compliant with the Smart Battery Data Specifications (SBDS). Batteries must be charged with a power adapter that is also provided with the system.

Other batteries can also be used with the system as long as they are SBDS-compliant. Many major manufacturers provide these products and they are easy to access around the world.

The batteries provides enough power to operate the instrument throughout a normal survey day. However, battery lifetime decreases as the ambient temperature decreases. At 25°C, the newly installed batteries last for 15 to 16 hours but at -10°C, the batteries last for only seven hours.

Understanding Temperature Effects

A typical plot of CG-5 service hours against the ambient temperature for the Smart Battery is shown in Figure 6 below. At low temperatures, the service hours decrease rapidly for two reasons:

- low temperatures reduce the inherent electrochemical capacity of the battery
- the load on the battery increases as the temperature drops, in order to maintain the CG-5 sensor at its constant operating temperature.

To circumvent the first effect and extend the battery life under cold weather conditions, an external battery belt (optional) can be provided. The battery belt is strapped to the operator's waist underneath the clothing and thereby kept warm. An extender cable to the charger plug on the Autograv provides power to the instrument.

Once the external battery supply has been connected, the internal battery if discharged, should be removed, as it should not be kept in place for very long thereafter. When the internal battery has been replaced, the external battery may be then disconnected without any interruptions of the temperature stabilization of the sensor.

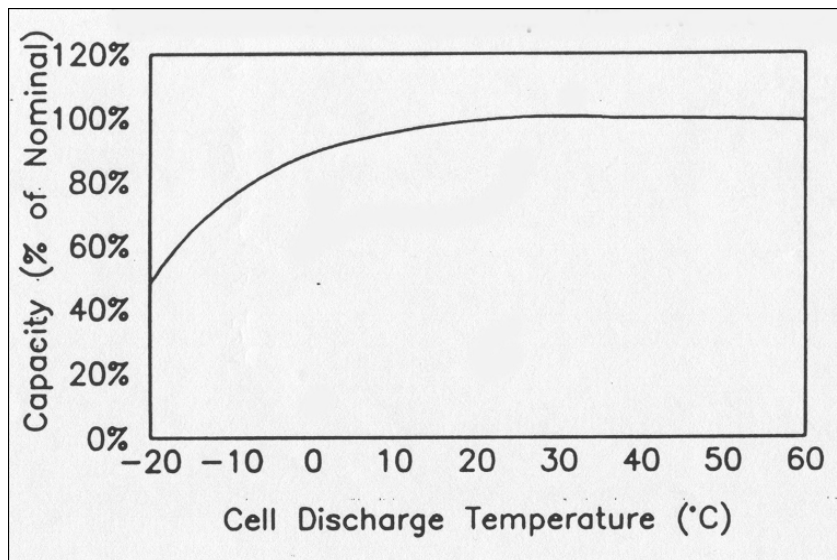

**Figure 5-1 - Typical CG-5 Capacity vs. Temperature
(Moltech Smart Battery NI2020)**

Monitoring Voltage

Low battery warning - If the battery capacity for BOTH batteries drops below 10%, the system emits an audible low battery level alarm. The battery should then either be recharged by connecting the instrument to the charger or replaced with a charged battery

Checking the battery - You can check battery at any time by looking at the:

- battery icon on the lower right of the display
- battery 1 time left and battery 2 time left indicators that can be accessed via the INFO key

Understanding Life Expectancy

The life expectancy of the battery is approximately 300 cycles (each cycle being a complete discharge and recharge). The battery pack should be maintained in storage at 25° to maintain its shelf life. If storage temperatures exceed 25°C over a one year period, it may be necessary to recharge the battery. In standby operation, the life expectancy is 4 to 5 years. Two batteries are supplied with each Autograv.

If the CG-5 battery has been in use in the field for 150 to 200 days, then its capacity to hold a charge may be significantly less than it was new. At this point, it is more economical to replace the battery with a new one, rather than suffer with the operational inconvenience of a reduced battery life and frequent battery changes in the field.

Replacing a Battery

You should replace both of your batteries with new ones, approximately once a year if your CG-5 has been in relatively steady use. You should replace an individual battery even earlier, if you should find that its capacity has been reduced, even after it has been fully charged.

When replacing a CG-5 battery it is recommended that you do so only with one of a type which is compliant with the Smart Battery Data Specification (SMDS) standard.

Some additional guidelines are:

- Do not store discharged batteries in cold temperatures.
- Replace a battery after about 200 days of field use, as it will no longer provide a proper lifetime in the field.

Changing or Inserting a Battery

To change or insert a battery:

- a. Position your fingers in the recessed pull slot on the battery (battery compartment plug).
- b. Pull the plug out of its slot.
- c. Pull the discharged battery out of its bay and push the new battery into the slot.



Figure 5-2 - Battery Installation

Using the Power Adapter

The CG-5 has a built-in charger that is attached directly to the main powerboard in the system. Therefore, to charge the 11.1V batteries, you are only required to attach an external power adapter which supplies the required DC voltage. The DC power adapter has an input range from 90V to 264V.

The power adapter can also be used to power up the Autograv via an AC outlet. When the charger is connected to the Autograv it provides current to other internal batteries in the system, such as the clock battery. It also enables the Smart batteries to be removed without affecting the performance of the instrument.



Note:

Charge batteries according to manufacturer's specifications. When charging the batteries, remove the plugs from the battery compartment, because of possible flammable gas exhaust. Replace the plugs only when charging is complete. This can be determined by looking at the INFO screen which shows time left for each of the two Smart batteries.

Estimating Charging Time

Batteries are charged by applying a constant voltage. The charging current is self limiting. When the Autograv is connected to the charger, the battery in the instrument (if connected inside the battery compartment) is automatically charged. Up to two spare batteries can be recharged by plugging them into the sockets on the side of the charger.

Charging time for two batteries is approximately eight hours. The ambient temperature should be in the 0° to 45°C range.

Charging Notes

The following notes provide guidelines for charging the Smart batteries in the system.

- If the instrument has a discharged battery in it when the power adapter is connected, then wait for 1 to 2 hours before plugging in another discharged battery into a side socket.
- If the ambient temperature is below 0°C, then do not charge a battery.



Important:

Do not connect the Autograv to any external 12V DC-supply other than a spare Autograv battery or the authorized charger supplied by Scintrex unless you are certain that it will not exceed 15V. For example, do not power the Autograv from the electrical system of a vehicle, the voltage from such sources may readily exceed the permissible input voltage to the Autograv and *cause serious damage* to its electronic system, thus voiding the warranty.

Using the external battery belt

In cold weather operation, i.e. below -20°C , an external battery belt (P/N 867021) is strongly recommended.



Figure 5-3 - External Battery Belt

Connect one to three batteries to the appropriate connectors in the battery belt.



Figure 5-4 - External Battery Belt

Connect the external battery belt to the external power supply connector on your CG-5



Figure 5-5 - External Power Supply

Adjusting Instrument Parameters

There are several instrument parameters that you need to periodically check and adjust via the keypad, if required. As the instrument gets older, you will not have to check these parameters as often.

The parameters that require periodic checks and adjustments are:

- Drift
- Tilt offset
- Tilt sensitivity
- Calibration constant

This chapter describes these procedures, and also provides trouble-shooting tips and information on contacting Scintrex should assistance be required.

Applying Drift Corrections

During the first month of operation for a new instrument, check the drift correction twice a week.

1. After this four week period, check the drift correction twice every month or longer depending on the individual characteristics of the instrument.



Important:

If an instrument has been turned off for several weeks or more (which should never be done unless absolutely necessary), then you should implement the setup procedures outlined in “Automated Drift Adjustment Software” on page 5-11 or “Adjusting Drift Manually” on page 5-13.

2. In any event, the drift correction must be checked at intervals of no more than three months apart and the drift value and start time updated accordingly.

Obtaining Accurate Results

The following provides a few guidelines for obtaining best results with your CG-5:

- The drift correction should not be adjusted on the basis of repeat measurements at base stations during a field survey, but rather with drift measurements obtained from a stationary instrument. The drift correction feature corrects for relatively constant long term instrument drift due to stress relaxation in the elastic system.
- There may be a small amount of additional drift induced by transportation and handling. The drift correction is not intended to eliminate drift due to transportation as it is generally not constant and depends on the conditions of transportation. This residual drift can be determined by repeated measurements at selected base stations.
- Ensure that the tide correction is selected and properly adjusted while measuring the drift correction.
- To obtain the most accurate estimate of instrument drift, dump the data and process it with an appropriate data processing package or program.

Automated Drift Adjustment Software

The CG-5 provides a software-based automated method to determine the drift constant and update the internal correction information automatically. This method provides a convenient way to determine the drift constant which is accurate for most applications. For the highest accuracy dump the data and process it offline.

Enabling the Drift Constant Routine

First set the instrument up on the tripod on a stable surface in a quiet location.

Access the Service menu. The system displays the SERVICE MENU screen.



Press the arrows to select the User Calibration option.

Maintaining Your CG-5 and Trouble-shooting

Press the ENTER key to select the DRIFT correction. The screen should appear as shown below.

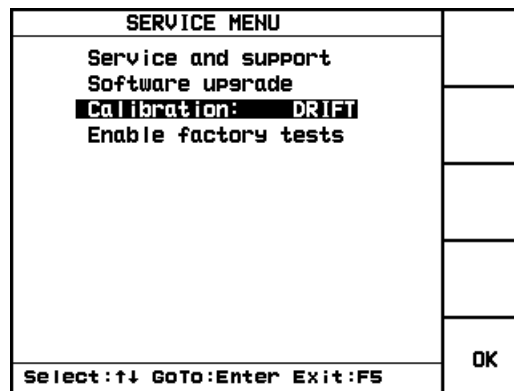

PRESS



Press the F5 <OK> key to exit.

Access the Options menu and set the CG-5 in auto-repeat mode with a suitable read time. For example set read time = 60s, number of cycles = 88888. This will repeat a 60s reading 88888 times or until the stop key is pressed.

PRESS



Press the F5 <OK> key when finished.

Level the instrument (using the tripod setup procedures) to within -10 to + 10 arcseconds about both axes.

PRESS

A yellow rectangular button with rounded corners and a black border. The text "MEASURE" is on the top line and "CLR" is on the bottom line, both in black capital letters.

Press the <MEASURE/CLR> key. The Autograv now automatically takes and records a reading once every 60 seconds.

After approximately 12-24 hours, *press* the F5 <STOP> key. The system automatically displays a message box showing the old and new drift constant values and the standard deviation for the estimate of the new value.

Accept or decline the new value as directed. If you accept, the new Drift constant is automatically updated in the system.

Note that the period for measuring the drift constant is arbitrary - for best results 12 to 24 hours is recommended.

Adjusting Drift Manually

As an alternative to the drift correction method provided in the CG-5 software, some users may prefer to use traditional manual methods of evaluating drift.

Measuring Drift

First set the instrument up on the tripod on a stable surface in a quiet location.

Access the Options menu and set the CG-5 in auto-repeat mode with a suitable read time. For example set read time = 60s, number of cycles = 88888. This will repeat a 60s reading 88888 times or until the stop key is pressed.

PRESS

A yellow square button with rounded corners and a black border. The text "F5" is in the center in black capital letters.

Press the F5 <OK> key when finished.

Level the instrument (using the tripod setup procedures) to within -10 to + 10 arcseconds about both axes.



Press the <MEASURE/CLR> key. The Autograv now automatically takes and records a reading once every 60 seconds. .

After 12 - 24 hours, *press* the F5 <STOP> key.

Output the data to a computer. For details on this procedure, please see Chapter 3, "Operating the CG-5 in the Field" and the "Dumping Data" topic that starts on page 3-20.

Below is a procedure for calculating the Drift constant. The data could also be processed in a spreadsheet or other processing package.

Reading the Data

From the listing, take one reading (**R1**) at time **T1** close to the start of the recording period and another reading (**R2**) at time **T2** from near the end of the period.



Important:

Do not use readings which are obviously noisy or disturbed.

From these values, calculate a new Drift Correction.

$$\text{DRIFT}' = \text{DRIFT} + \left[\frac{\text{R2} - \text{R1}}{\text{T2} - \text{T1}} \right]$$

where:

DRIFT is the Drift constant in the instrument during readings and (T2-T1) is in units of days.

Example

Selecting: **T2 = 15:10:30**
T1 = 14:56:27

Gives the corresponding readings: **R2 = 3969.418**
R1 = 3969.382

and

DRIFT = 0.000
R2 - R1 = 0.034 mGal
T2 - T1 = 0.23383 hrs = .00974 days

Therefore,

DRIFT' = -3.6949 (µGal/day)

Adjusting the Drift Correction

The final step is to apply the calculated drift correction. To do this:

PRESS  *Select* the AUTOGRAV icon in the main SETUP screen and *press* the F5 key. The system displays the AUTOGRAV PARAMETER setup screen.

PRESS  *Press* the F1 <NEXT PAGE> key to access the second AUTOGRAV PARAMETER setup screen.



PRESS  *Press* the F3 key to change the mode from FUNCT to EDIT.

Enter the Drift value you have just calculated.

When finished, *press* the F5 <OK> key to record your changes and exit from the screen.



Important:

With a new instrument, check the Drift Correction once a week for 4 weeks. After this period, check approximately once a month. For most sensors, the drift rate will go down as they age, especially during the first couple of months.

Applying Tilt Corrections

The perfect tilt adjustment condition is the coincidence of instrument zero tilts as defined by the digital readout of the level bubbles and tilts referred to the horizontal as defined by the maximum gravity sensor output.

A further condition required for the tilt compensation to work properly is that the tilt sensor sensitivity is properly adjusted.

The tilt sensors are adjusted before the instrument leaves Scintrex Limited. Since the tilt sensors are very stable under normal operating conditions they only need to be checked approximately every two months.

Adjusting Tilt Sensor Offsets (TiltX.Offs and TiltY.Offs)

The Autograv provides for correction of the tilt sensor offsets or zero errors **TiltX.Offs** and **TiltY.Offs** through software. To update these constants, you must perform **TiltX.Offs** and **TiltY.Offs** adjustments.



Note:

You should perform this calibration approximately once every two months.

Performing TiltX.Offs Adjustment

Ensure that the tide correction is selected and that the tide and drift correction are properly adjusted. Select the Cont. Tilt Corr. on the first page of the AUTOGRAV menu.

Place the Autograv on the tripod in a quiet location with a solid floor (concrete is preferable). A wooden floor or carpet is *not suitable*.

Access the OPTIONS screen.

PRESS



Press the SETUP key. The following screen is displayed:

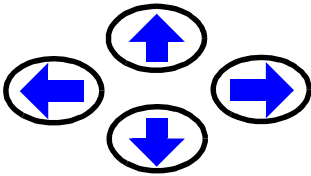
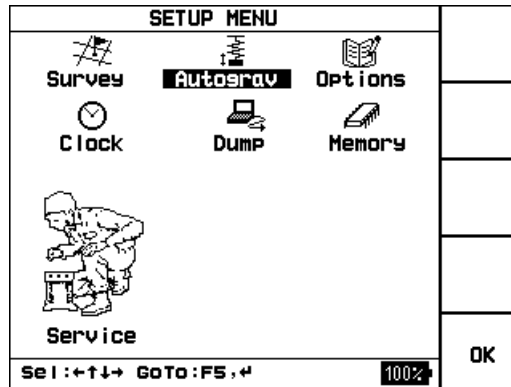

Use the arrow keys to navigate to the Options item. The word Options is highlighted as follows:



PRESS



Press the F5 <or ENTER> key. The following screen is displayed:

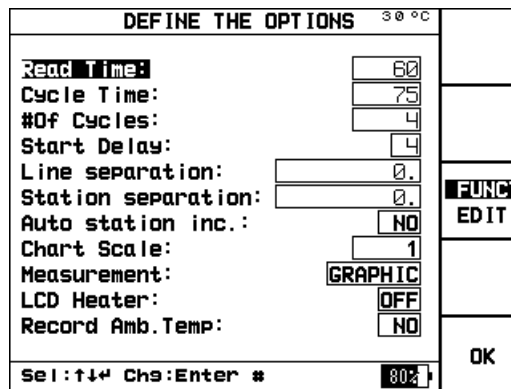

PRESS



Press the F3 <FUNCT/EDIT> key to highlight the EDIT function as follows:

EDIT



Press the up or down arrow keys to bring your cursor to the read time parameter. Note that the cursor is automatically positioned in the field ready for editing.

Set the read time to 60 sec, the cycle time to 75 sec and No. of cycles to 0. In a quiet location the read time can be reduced to say 30sec, while in a noisy location it should be increased - to, say, 120 sec. Before leaving the Options Screen set the start delay to 4 sec so that the instrument can stabilize, undisturbed, before the reading starts.

PRESS



Press the F5 key. Your changes have been updated.

Access the Service menu.

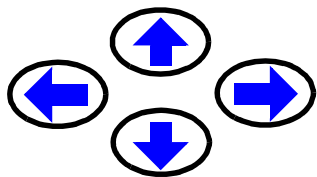

In the set-up screen, *press* the arrow keys to bring the cursor to the service icon.

The word Service is highlighted, as illustrated below:

Service

PRESS



Press the F5 <or ENTER> key. The following screen is displayed:

SERVICE MENU	
Service and support	
Software upgrade	
Calibration: OFF	
Enable factory tests	
	OK
Select:↑↓ Goto:Enter Exit:F5	

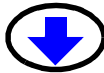

Press the arrows to select the User Calibration option.

PRESS



Press the ENTER key to select the XYSENS correction. The screen should appear as shown below:

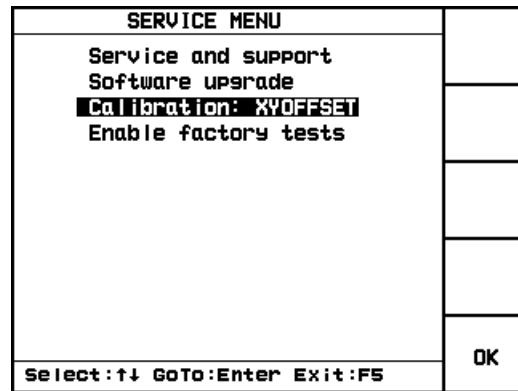

PRESS



Press the F5 <OK> key to exit from the screen.

PRESS



Press the MEASURE key. The system displays the STATION DESIGNATION screen.

PRESS



Press the F5 <LEVEL> key or the MEASURE key. The system displays the LEVELING screen with a series of X-axis and Y-axis items accessed via the function keys.

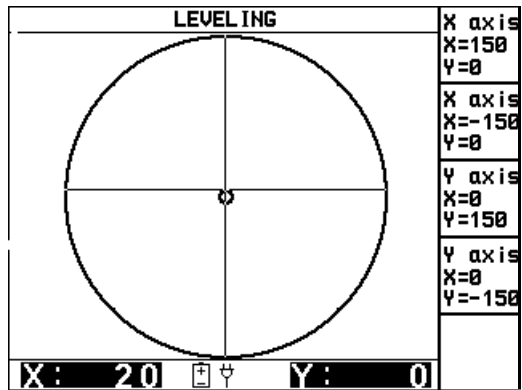

Adjust the tripod until $X = 150 \pm 10$ and $Y = 0 \pm 5$ in the LEVELING screen.

PRESS 

Press the F1 <X=150, Y=0> key. The system measures until the reading time has elapsed or the F5 <STOP> key is pressed.

PRESS 

Press the F5 <FINAL DATA> key to view the data in the AUTOGRAV FINAL DATA screen. The system then overlays a User Calibration window with values of X1 and R1.

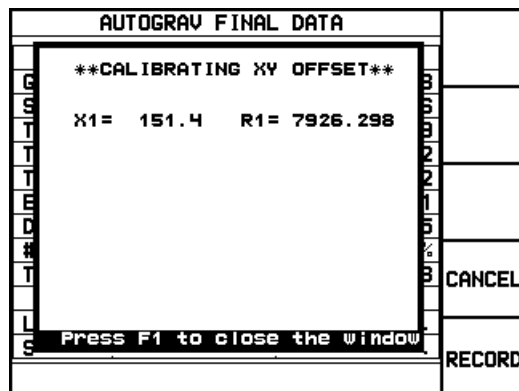

PRESS



The system stores the **X1** and **R1** values for internal calculation. *Press* the F1 key to clear the overlay. Next the reading can be either stored or deleted by pressing the RECORD or CANCEL keys. Note that the choice here does not affect the internal offset calculation.

Access the LEVELING screen again:

- by pushing the MEASURE key twice if you did not record the data.
- by pushing the MEASURE key once if you did record the data.

Adjust the tripod until $X = -150 \pm 10$ and $Y = 0 \pm 5$ in the LEVELING screen

PRESS



Press the F2 <X=-150, Y=0> key. The system measures until the reading time has elapsed or the F5 <STOP> key is pressed.

PRESS



Press the F5 <FINAL DATA> key to view the data in the AUTOGRAV FINAL DATA screen. The system then overlays a User Calibration window with:

- values of tilt and gravity readings
- The error in the current offset value
- the existing Tilt X. Offset (Old X Offset)
- the new calculated Tilt X. Offset (New X Offset).

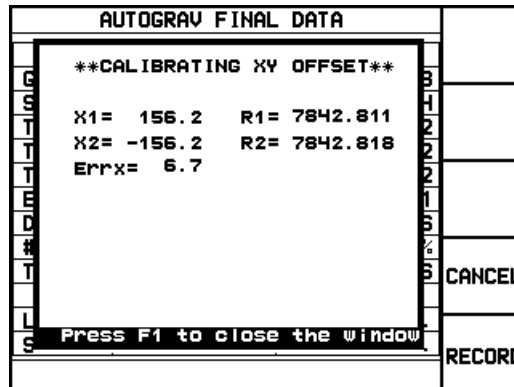

Press F2 to accept or F3 to reject the New X Offset. If the value is accepted the instrument internal constants are automatically updated.



Note: The difference between the old and the new offsets should be relatively small in most circumstances. Less than say 10 or 20 arcseconds. If the reported error is larger than this there has probably been a problem with the measurement.



Important:

Do not accept the value and repeat the measurement. If the reported error is larger than 100 arcsec and you have repeated the measurement several times contact Scintrex before accepting the New X Offset.

Repeat the measurement of TiltX.Offs to check that the error is less than 1 arcsec.

Performing TiltY. Offs Adjustment

This process is analogous to the process for obtaining TiltX. Offs described above.

In this case, however, you will first adjust the rear footscrews until $Y = 150 \pm 0$ and if necessary, adjust the front footscrews until $X = 0 \pm 5$.

The second step is to adjust the rear footscrews until $Y = -150 \pm 10$ and if necessary, adjust the front footscrews until $X = 0 \pm 5$.

When both the X and Y offsets are completed,

Press the F5 key to return to the Service menu.

PRESS



Adjusting Tilt Sensor Sensitivity (TILTXS, TILTY S)

This adjustment is performed after both the tilt offset adjustments are made. In general, the tilt sensor sensitivity is more stable than the zero point, so it only needs to be checked once every four months.

Adjusting X-axis Sensitivity

Set the gravimeter up in the same way as for the Tilt Offset measurements.

Access the Service menu. The system displays the SERVICE MENU screen.

Press the arrows to select the User Calibration option.

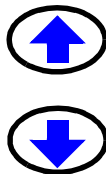

Maintaining Your CG-5 and Trouble-shooting

PRESS

ENTER

Press the ENTER key to select the XYSENS correction. The screen should appear as shown below.

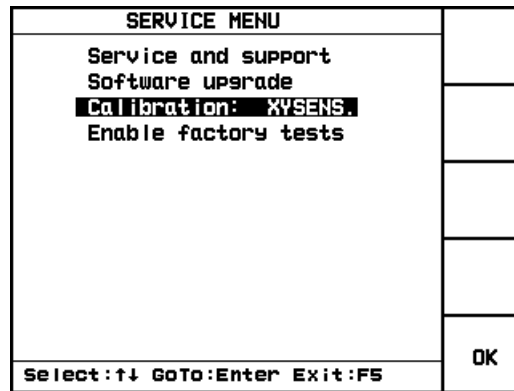

PRESS

F5

Press the F5 <OK> key to exit from the screen.

PRESS

MEASURE
CLR

Press the MEASURE CLR key. The system displays the STATION DESIGNATION screen.

PRESS

F5

Press the F5 <LEVEL> key or the MEASURE key. The system displays the LEVELING screen with a series of X-axis and Y-axis items accessed via the function keys.

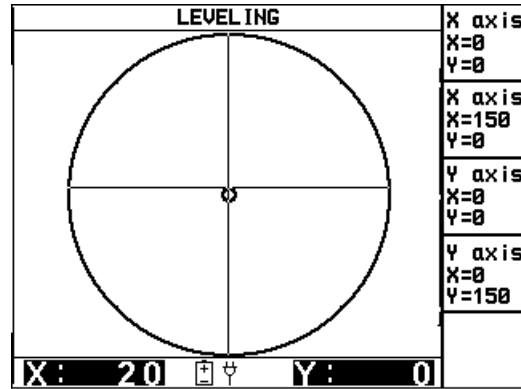

Adjust the tripod until $X = 0 \pm 10$ and $Y = 0 \pm 5$.

PRESS



Press the F1 <X=0, Y=0> key. The system measures until the reading time has elapsed or the F5 <STOP> key is pressed.

PRESS



Press the F5 <FINAL DATA> key to view the data in the AUTOGRAV FINAL DATA screen. The system then overlays a User Calibration window with values of **X1** and **R1**.

The system stores the **X1** and **R1** values for internal calculation. Press the F1 key to clear the overlay. Next the reading can be either stored or deleted by pressing the F4 <RECORD> or F5<CANCEL> keys. Note that the choice here does not affect the internal sensitivity calculation.

Access the LEVELING screen again:

- by pushing the MEASURE key twice if you did not record the data
- by pushing the MEASURE key once if you did record the data

Adjust the tripod until $X = 150 \pm 10$ and $Y = 0 \pm 5$ in the LEVELING screen

PRESS 

Press the F2 <X=150, Y=0> key. The system measures until the reading time has elapsed or the F5 <STOP> key is pressed.

PRESS 

Press the F5 <FINAL DATA> key to view the data in the AUTOGRAV FINAL DATA screen. The system then overlays a User Calibration window with:

- values of tilt and gravity readings
- the existing Tilt X Sensitivity (Old X Sensitivity)
- the new calculated Tilt X Sensitivity (New X Sensitivity)

Press F2 to accept or F3 to reject the New X Sensitivity. If the value is accepted the instrument internal constants are automatically updated.

Repeat the measurement of Tilt X Sensitivity to check that the values for **R0** and **R1** are zero or close to zero.

Adjusting Y-axis Sensitivity

This process is analogous to the process for obtaining X-axis sensitivity measurements.

PRESS 

In this case, however, you will level the instrument until $Y = 0 \pm 10$ and $X = 0 \pm 5$ and *press* F3.

PRESS 

You will then adjust the tripod until $Y = 150 \pm 10$ and $X = 0 \pm 5$, and press F4.

PRESS 

When both the X and Y Sensitivity measurements are completed return to the Service menu and turn the User calibration off with the Enter key.

Adjusting Tilt Sensor Cross-Coupling

This adjustment reduces cross-coupling between the tilt sensors and reduces the effect that an adjustment about the X-axis has on the output of the Y sensor. The cross-coupling should be very stable and only needs to be measured and adjusted in the event that you replace the baseplate of the instrument (sometimes required after many years of service).

Measuring Cross-Coupling

PRESS

 A yellow rectangular button with rounded corners and a black border. The text "MEASURE CLR" is centered in black, uppercase letters.

PRESS

 A yellow rectangular button with rounded corners and a black border. The text "F5" is centered in black, uppercase letters.

- Place the Autograv on the tripod in a quiet location with a solid floor (concrete is preferable). A wooden floor or carpet is not suitable.
- Rotate the tripod footscrews eight turns up from their bottom positions.
- Press** the MEASURE CLR key. The system displays the STATION DESIGNATION screen.
- Press** the F5 <LEVEL> key. The system displays the LEVELING screen.
- Level the instrument until $X = 0 \pm 10$, $Y = 0 \pm 1$.
- Wait 5 minutes and observe the Y tilt. Record the value as Y0.
- Rotate the front footscrews *clockwise* five turns. Observe the Y tilt and record the value as Y1.
- Rotate the front footscrews *counter-clockwise* five turns. Observe the Y-tilt and record the value as Y2.

The cross coupling specification is:

$$|Y2 - Y0| < 5$$

$$|Y1 - Y0| < 5$$

If this specification is not met, then proceed with the steps as outlined in “Adjusting the Cross-Coupling” next.

Adjusting Cross-Coupling

- a. Place the Autograv on the tripod in a quiet location with a solid floor (concrete is preferable). A wooden floor or carpet is not suitable.
- b. On a piece of protective foam, lay the Autograv down on its front and view the bottom of the instrument. See the figure below:

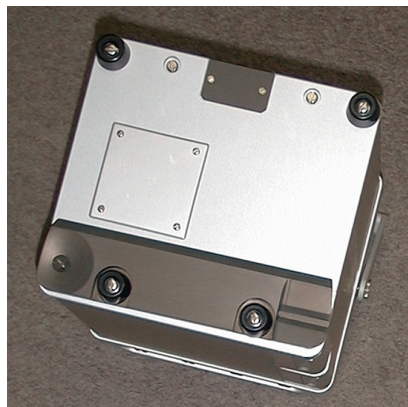

Figure 5-6 - Bottom of Autograv Slider Plate. The slider plate is the horizontal grey plate with a cone and vee-groove and two screws shown above.

PRESS

MEASURE
CLR

PRESS

F5

- c. Loosen the two screws on the slider plate until the plate can slide freely.
- d. Raise the tripod feet eight (8) turns from their bottom positions.
- e. Place the instrument onto the tripod.
- f. **Press** the MEASURE CLR followed by the F5 <LEVEL> key to prepare for leveling.
- g. Level the instrument until $X = \pm 10$, $Y = \pm 1$

- h. Wait 5 minutes and observe the Y-tilt Record the value as Y_0 .
- i. Rotate the front footscrew *clockwise* five turns. Observe the Y-tilt value on the LEVELING screen.
- j. Hold the tripod in place as it must not move during this step. Rotate the instrument on the tripod until $Y = Y_0 \pm 5$ (if $Y < 0$, then rotate instrument *clockwise*).



Note:

The slider plate should slide relative to the case. If possible, have a second person hold the tripod.

- k. Tighten the two screws on the V- groove plate.
- l. Repeat steps h. and i. The difference in Y (i.e. $Y_0 - Y$) should be less than 5 seconds. If it is not within this range, then repeat the adjustment procedure.

Re-Calibrating the CG-5

As explained on page B-9, the calibration factors **GCAL1** and **GCAL2** are applied to the gravity signal, according to Equation (B.4). The calibration factor **GCAL2**, which accounts for a small quadratic nonlinearity, is evaluated in the Scintrex gravity laboratory. Since 1991, it has been reduced to zero by an electronic adjustment. The **GCAL2** need not be re-evaluated.

The main calibration constant, **GCAL1**, is determined on the Orangeville Calibration Line, 70 km north of Toronto. This line, which includes two absolute stations, was established and is maintained by the Geological Survey of Canada. The section used for the CG-5 calibration and testing consists of 5 stations spread over a distance of 70 km covering a gravity interval of 119.218 mGal. Instruments are transported by car, strapped onto the back seat with no special transport case or fixtures.

Readings are taken at each station on the way up the line and repeated on the way down. Readings of DUR = 60 seconds are taken. Earth tide corrections are made automatically with the instrument's built-in program.

A linear residual drift correction is applied, off line, on the basis of repeat readings at station 1. The difference S_{ij} , between drift corrected readings at station 1 and station *i* is then calculated. The measurement error for a gravity difference is defined as

$$E_{ij} = k * S_{ij} - g_{ij}$$

where g_{ij} are the reference gravity differences and **k** is a constant (the scale correction factor) which is varied until the standard deviation of the measurements errors is minimized. The new scale factor **GCAL1'** is then calculated from the old value **GCAL1** used during the calibration test as

$$GCAL1' = k * GCAL1$$

The accuracy of the **GCAL1** determination is about 0.01% (0.01 mGal measurement error in 119 mGal gravity test range).

The **GCAL1** stability depends on the dimensional stability of the capacitive displacement transducer, and the stability of the internal D.C. reference voltage. After the initial period of a few months, during which the **GCAL1** may change, due to the stress relaxation effects in the newly fused quartz sensor, by up to 0.1%, the drift rate of the scale factor **GCAL1** is commonly 1 to 2 ppm (parts per million) per day. After a few years, users requiring

greatest precision, in particular for regional surveys, may wish to recalibrate their gravimeters. This could be done in a similar way as it was done initially at Scintrex.

In order to derive the new **GCALI** at least two locally available stations with the reliably determined gravity difference of at least 100 mGal are necessary. Additional intermediate well determined gravity stations will serve to increase the precision of this determination. By looping back to the starting station the residual drift should be determined, and used for correction of readings at other stations. Beware that some older calibration ranges were established by using LaCoste-Romberg gravimeters before the existence of cyclic measurement screw errors was known and the corrections for it applied, and that therefore they may not be very accurate.

Other Helpful Hints

Following are some other basic hints for maintaining your equipment to its peak operating efficiency.

Maintaining the Tripod

The tripod footscrew adjustment threads are protected by a stainless steel sleeve at the tripod base and a plastic wiper in the bottom of each footscrew. The stainless steel sleeve should be periodically maintained by winding the tripod footscrews to the top of their travel, and then cleaning and lightly oiling the sleeve.

Storing the Autograv

There are several steps that you must follow in order to obtain the best results from your instrument:

- Level the Autograv
- Always keep the Autograv connected to the powered up battery charger when not in use.
- Store the Autograv in a dry secure place.
- During storage, remove the battery compartment door to prevent a buildup of gases which **could** vent from the **batteries**.

Trouble-shooting

Despite the fact that your CG-5 is a very reliable instrument, there can be circumstances where problems may occur. The following table lists some of these problems and their attempted solution. However, please do not hesitate to contact your nearest Scintrex office. See “Warranty and Repair” on page 5-46 for the office nearest you.

Problem	Possible cause	Possible solution
Autograv will not power up	Battery is depleted.	Plug in charger and charge battery or install a fully charged battery.
Screen is completely dark or light	Contrast is not adjusted properly	Press the DISPLAY key and press the F2 (50%) key.
Screen or keypad does not work	Computer needs to be re-set.	Reset the Autograv by pressing ON / OFF and F1 at the same time.
Reading appears to be out of range or reading is close in value to GCAL1 and ERR/SD is low.	Sensor may be latched.	Gently tap the upper panel underneath the Autograv name with your finger several times.
		Take a new reading so that the instrument does not average the incorrect reading.
		If the reading is still incorrect, repeat the steps increasing the number of taps until the sensor unlatches.
Battery does not appear to be reporting its status correctly and is not charging and discharging in the normal manner - e.g. charges more quickly than normal and has reduced capacity	Battery calibration has been lost	Battery does not appear to be reporting its status correctly and is not charging and discharging in the normal manner - e.g. charges more quickly than normal and has reduced capacity

Maintaining Your CG-5 and Trouble-shooting

Battery does not appear to be reporting its status correctly on the CG-5 screen	Internal battery charger needs to be reset	Reset the battery controller by removing a battery or disconnecting the external power supply cable for a few seconds
Display changes slowly	Ambient temperature is too cold for the display to operate properly.	Keep console warm. Purchase optional display heater.
Data does not dump	RS-232 or USB cable is not connected between CG-5 and PC.	Connect cable. For information, see "Dumping Data" on page 3-38.
	RS-232 or USB cable is not connected to PC	Connect cable. For information, see "Dumping Data" on page 3-38.
	File transfer program is not installed properly	Check installation of SCTUTIL program. For information, see "Installing SCTUTIL" on page D-2.
Instrument does not respond even after the reset procedure described above	Instrument needs cold boot	Switch instrument off with the ON/OFF key. Hold down the SETUP key while switching instrument on again with the ON/OFF key. If you wish to restore the default settings first dump your data by USB as instructed

Trouble-shooting your USB port

If you are unable to dump your data or upgrade your system, the USB port may not be working properly. The following is an exhaustive list of reasons and remedies for USB port problems.

Incompatible operating system

Microsoft Windows 95 and NT operating systems are not compatible with CG-5 USB drivers. The following Operating Systems supports CG-5 USB drivers and have been tested to be compatible.

Windows 98

Windows XP Professional Edition

Other Operating Systems may support USB technology, but are not compatible with CG5 USB drivers:

Windows 95 or Windows 3.X

Windows 2000 Professional

Windows XP Home Edition

Prevent power loss from the USB port

1. Click **Start, Control Panel**.
2. If necessary, click **Switch to Category View**.
3. Click **Performance and Maintenance**.
4. Under **Control Panel Icon**, click the **System** icon. The **System Properties** window displays.
5. Click the **Hardware** tab.
6. Click **Device Manager**. The Device Manager window displays.
7. Select **Universal Serial Bus controllers**.
8. Right-click **USB Root Hub**.
9. Click **Properties**. The **USB Root Hub Properties** window displays.

10. Click the **Power Management** tab.
11. Clear the check box next to **Allow the computer to turn off this device to save power box**. (This will prevent a power loss to the USB port.)
12. Click OK to close the **USB Root Hub Properties** window

CG5 device or computer hardware issue

If you are unable to turn on your CG5 device, follow the Instruction Manual. CG5 saves battery power by turning off automatically if you do not use it for a certain length of time. If you still cannot turn on the CG5 when following the instructions, use a fully charged battery or connect the CG5 to the AC power with its AC power adapter. Then turn it on. After turning on your CG5 (and reconnecting if necessary), follow the software instructions in order to work with it.

Cable disconnected, loose or defective

Check the cable connections on your CG5 and the computer. Make sure the connectors are firmly attached. Please check if there are defects on your cable. If the cable is broken or kinked, get a new cable.

Faulty USB connect on computer

One of the USB connectors on your computer may be faulty. To check this, connect the USB cable of your CG5 to the other USB connector on your computer. (Most computers have two USB connectors located next to each other). It is not necessary to turn off the computer before connecting the cable to the other USB port.

Incorrect USB or device setup in Windows

After checking the hardware issues, check the status of USB and your CG5 in the Windows Device Manager using the steps below:

Checking USB and CG5 status in Device Manager

1. Right-click **My Computer** on the Windows desktop and then click **Properties**.
2. Click the **Device Manager** tab to display the Device Manager window as shown at the right. (For Windows 2000 systems, click the **Hardware** tab and then the **Device Manager** button.
3. In the Device Manager list, click the + sign next to **Universal serial bus controller**.
4. Verify that a USB host controller and a USB root hub are listed below Universal serial bus.
5. If Universal serial bus controller, USB host controller or USB root hub are not listed, close the Device Manager and go to USB port incorrectly configured in BIOS.
6. If Universal serial bus controller, USB host controller and USB root hub are listed but one or more display a yellow exclamation point, go to USB controller IRQ conflict.
7. If you have Windows XP, right-click the Host Controller and select Properties from the drop-down menu. If you see this status message in the Properties window: The drivers for this device are not installed.
8. If Universal serial bus controller, USB host controller and USB root hub are listed but one or more display a red X, go to USB controller or root hub disabled in Windows Device Manager.
9. If your CG5 is listed in the correct location without a yellow exclamation point, go to USB chipset problem.
10. If your CG5 device does not appear in the correct device category, or if your CG5 is incorrectly listed under **Other Devices you must uninstall that device and then follow the instructions to install proper CG5 USB driver. (Refer to the manual for proper steps)**

USB port incorrectly configured in BIOS

NOTE: The procedure in this section is intended for advanced users only. Incorrect BIOS settings could prevent your computer from starting or operating normally. If you are not experienced in making changes to your computer BIOS, consult your computer instructions or contact your computer manufacturer for assistance before attempting the steps below.

1. Follow the instructions of your computer to view the BIOS settings. These settings are sometimes called CMOS settings or system setup.
2. To view the BIOS settings, press a key, such as F2 or Delete, just after you turn on the computer. Instructions often appear on the screen briefly when you turn on the computer. Also check the instructions and manuals provided with your computer.
3. Look for **USB Interface** or a similar setting in the **Advanced Setup, Peripheral Configuration** or another section of your computer BIOS settings.
4. Follow the onscreen instructions or read the computer documentation to enable the USB port.
5. Follow the onscreen instructions to save the new settings and restart the computer.
6. Turn on your CG5 and follow your software instructions to start using your CG5 with the computer.

USB Controller or root hub disabled in Windows Device Manager

1. Right-click **My Computer** on the Windows desktop and then click **Properties**.
2. Click the **Device Manager** tab. (On Windows 2000 and XP systems, click the **Hardware** tab and then the **Device Manager** button.)
3. In the Device Manager list, click the + sign next to **Universal serial bus controller**.
4. Click the line in the Device Manager containing the red X.
5. Click the **Properties** button. (On Windows 2000 and XP systems, click **Properties** on the **Action** menu.)
6. In the **Communications Port Properties** box, click the **Resources** tab.
7. Re-enable the USB device by clicking the **Enable Device** button and follow the onscreen instructions.

USB controller IRQ conflict

If the USB universal serial bus controller, the USB host controller, or the USB root hub is displayed in the Windows device manager with a yellow exclamation mark, your computer probably has an IRQ conflict. To resolve this issue, refer to your computer instructions or contact your computer manufacturer. After you resolve the IRQ conflict (usually by disabling an infrequently used device to make its IRQ available for the USB port), turn off and follow your software instructions in order to use your CG5 with the computer.

CG5 driver installed incorrectly

For a proper setup, a USB Device Driver must be installed on your computer before you can run SCTUTIL software. follow these steps:

1. Right-click **My Computer** on the Windows desktop and then click **Properties**.
2. Click the **Device Manager** tab. (On Windows 2000 and XP systems, click the **Hardware** tab and then the **Device Manager** button.)
3. Disconnect the USB cable from the computer.
4. On the Device Manager tab, click the + next to other devices. Then click the device representing your CG5 (below Other devices) to highlight it
5. In Windows 98 and Millennium, click **Remove** and click OK - Follow the onscreen instructions to remove the device from the Device Manager.
6. On Windows 2000 and XP systems, click **Uninstall** on the **Action** menu and click OK to confirm your action. Follow the onscreen instructions to remove the device from the Device Manager.
7. Reconnect the USB cable.
8. Follow the software instructions to start using your CG5 with the computer.

USB chipset issue

Some USB controllers (called the USB chipset) installed on computer motherboards are known to have problems communicating with some USB devices. Use the following steps to determine whether your connection problem results from the USB chipset on your computer and to obtain a software utility or patch to solve the problem.

1. Right-click **My Computer** on the Windows desktop and then click **Properties**.
2. Click the **Device Manager** tab. (On Windows 2000 and XP systems, click the **Hardware** tab and then the **Device Manager** button.)
3. Click the + sign next to **Universal serial bus controller**.
4. Write down the chipset identifying information as shown in the figure on the right.
5. Contact your computer manufacturer or go to their website to inquire about updates or patches available for your chipset.
6. If an update or patch is available, obtain and install it according to the instructions provided with it. If no USB software update or patch is available, or if one is available but you still cannot use your CG5 with your computer, contact Scintrex Customer information Center.

Removing USB entries from the Windows Device Manager

Cleaning up USB can only be done when your computer is in SAFE MODE.

Windows 98 - The following procedure can resolve Windows conflicts by removing old/unused device entries that are installed in virtual mode.

Windows XP and 2000 - Removing USB devices in Safe Mode will make the OS refresh the USB driver stack and may cause a shift in IRQ assignment.

Microsoft Windows 98 Startup Menu

```
1. Normal
2. Logged (\BOOTLOG.TXT)
3. Safe mode
4. Safe mode with network support
5. Step-by-step confirmation
6. Command prompt only
7. Safe mode command prompt only
Enter a choice: 1      Time remain-
ing: 06
```

To start Windows in SAFE MODE

1. Press the F8 or Ctrl key just before the Windows logo appears.
2. When the Start Up Menu appears, select SAFE MODE.
3. Windows will inform you that you are in SAFE MODE.
4. If you are using a USB mouse you may not have mouse support.

NOTE: If you remove the USB entries completely then it may create problems for the users who have both USB keyboard and mouse connected. Connect at least one PS2 device (mouse or keyboard) that will enable you to browse the device manager.

Removing USB completely

If USB is sharing an IRQ with another device and you are attempting to free the IRQ, or you need to refresh the USB driver stack, you must remove ALL USB elements completely. Windows will refresh the USB driver stack when you reboot to Windows Standard mode. In Windows Standard Mode (when the computer has started normally, no Safe Mode)

Unplug all USB devices except keyboard and/or mouse.

Uninstall the software for the **USB peripheral devices**.

Shutdown and start Windows in Safe Mode - **Device Manager**

Restart Windows in Safe Mode - go to **Control Panel - System Properties - Device Manager**.

In the View Tab, select the Show Hidden Devices Option

The order of removal must be followed exactly:

Delete USB peripheral devices (Scanners, Printers, Cameras CG5 ,etc.)

Delete HID and/or Composite USB (Human Interface Devices)

Delete USB Root Hub(s) (Universal Host Controllers)

Delete USB Host Controller(s) (Universal Host Controllers)

Please note that you can browse in Safe Mode using the keyboard Tab, by pressing Alt, Ctrl and Arrow keys. The Universal Serial Bus Controller and Human Interface Device headings should disappear completely from the Device Manager. Before starting Windows in Standard Mode:

Insert the Windows CD into the CDROM drive and browse to Look in (For example D: / Win98, where D is the letter of the CDROM drive on your system), Win9X folder on the CDROM when/if prompted.

Unplug all the USB devices before starting Windows.

USB does NOT like to share it's IRQ with another device especially when the user is employing sophisticated USB peripherals. Even though Windows may report NO conflict, if USB is sharing its IRQ with another system peripheral, (i.e. video, sound, SCSI etc.), that is often the source of the problem. (IRQ Holder for PCI Steering is NOT considered another device)

Windows XP USB 2.0 driver not installed

If your computer has a USB 2.0 controller built in, it may not have a Windows XP driver installed. Use this procedure to download and install the correct driver .Please keep in mind that CG5 driver is 1.1 version of USB and as such limited to 1.5 Mbits speed of operation . The speed of communication between CG5 and PC is negotiated during plug in .(So called Enumeration process) It is very important that the CG5 side of USB cable be connected to the CG5 first , than followed by PC side of the USB cable.

1. Download the USB 2.0 Windows XP driver from the Microsoft website or check for new USB drivers on your computer manufacturer's website.
2. Follow the instructions on the Windows Update site or the manufacturer's website to install the driver.
3. Reconnect the USB cable CG5 to PC.
4. Follow the software instructions in the Instruction Manual to start using your CG5 product with the computer

Warranty and Repair

Warranty

All Scintrex equipment, with the exception of consumable items, is warranted against defects in materials and workmanship for a period of one year from the date of shipment from our plant. Should any defects become evident under normal use during the warranty period, Scintrex will make the necessary repairs free of charge.

This warranty does not cover damage due to misuse or accident and may be voided if the instrument console is opened or tampered with by persons not authorized by Scintrex.

Repair

When To Ship the Unit

Please do not ship your instrument for repair until have communicated the nature of the problem to our Customer Service Department by e-mail, telephone, facsimile or correspondence. Our Customer Service Department may suggest certain simple tests or steps for you to do which may solve your problem without the time and expense involved in shipping the instrument back to Scintrex for repair. If the problem cannot be resolved, our personnel will request that you send the instrument to our plant for the necessary repairs and will issue a Return Material Authorization number (RMA) for this instrument.

Description of the Problem

The description of the problem is required. When you describe the problem, please include the following information:

- the symptoms of the problem
- how the problem started
- if the problem is constant, intermittent or repeatable
- if constant, under what conditions does it occur
- any printouts demonstrating the problem or data files

Shipping Instructions

No instrument will be accepted for repair unless it is shipped *prepaid*. After repair, it will be returned *collect*, unless other arrangements have been made with Scintrex. Please mention the instrument's serial number in all communications regarding equipment leased or purchased from Scintrex.

Head Office

Instruments should be shipped to:

SCINTREX Limited

222 Snidercroft Road

Concord, Ontario

L4K 1B5

tel: (905) 669-2280

fax: (905) 669-6403

e-mail: service@scintrexltd.com

Maintaining Your CG-5 and Trouble-shooting

6

Reference Information

This section provides information on:

- General specifications
- Hardware specifications
- Software specifications
- Application software specifications

General Specifications

Reading Resolution	0.001 milligal
Minimum Operating Range	8000 milligals, without resetting
Residual Long-term Drift	Less than 0.02 milligals per day
Typical Repeatability in Field Use	Less than 0.01 milligals standard deviation
Range of Automatic Tilt Correction	+/- 200 arc seconds
Interval Between Readings in Cycling Mode	Adjustable from 6 to 99998 seconds
Noise Rejection	Samples of more than 4 standard deviations (6 if the Seismic Filter is selected) from the average are rejected, if this feature is selected upon initialization of the instrument
Displayed and Recorded Data	Corrected Gravity Standard Deviation Tilt about the X-axis Tilt about the Y-axis Gravity Sensor Temperature Tidal Correction Duration of Measurement Terrain Correction Time at start of measurement and Header Information (including date and initialization constants)

Hardware Specifications

Graphic Display	Quarter VGA 320 x 240 LCD
Keypad Input	27 Keys for entering all commands, coordinates, header and ancillary information
Operating Temperature of the graphic display:	Standard operation -20°C to +45°C Optional heated operation -40°C to +45°C
Data Dump Connectors	2 COM (RS-232) ports, data and GPS (600 to 57600 baud) 1 USB port (12 Mbits / sec) 1 analog strip chart recorder output
Standard Memory	Flash technology Standard 12 Mbytes with approximately 200,000 readings without raw data setting When raw enabled 6 sample per second digitized samples, capacity depends on read time duration
Real Time Clock	Day, month, hour, minute and second Y2K compliant Continuous Lithium battery backup
Smart Power Supply	Dual Lithium camcorder type Capacity 6.6 Ah Automatic switching
Weight and Dimensions	Complete system is 336*215*201mm outside all connectors (336*190*177mm without connectors) and weighs 8.9 Kg Battery only is 336*215*86mm and weighs 6.4 kg

Software Specifications

Operating System	Scintrex Proprietary Embedded OS GUI Windows style In-field programmable (RS-232 and USB)
Automated Data Corrections	Tide, Instrument Tilt, Temperature, Advanced Noisy Reading Rejection, Seismic Noise Filter / FIR filter Near Terrain Corrections
Self Diagnostic	Data integrity upon power up Calibration parameters status
User Calibration	Easy graphic interface Automatic computation / storage of variables
Reading Data Presentation	Digitized Signal Graphic presentation (oscilloscope like) Numeric - one screen for all parameters Graphic cross-hair leveling presentation
Recall Data	Graphic line profile Numeric individual reading of all parameters
Data Dump	RS 232 and very fast USB Format: Binary data image Post-processed in: *.SGD (Scintrex proprietary format) *.TXT (full ASCII - headers and data) This is a text file and can be opened using NOTEPAD.EXE or WORDPAD.EXE. *.XYZ (ASCII data only spreadsheet type) This is a text file and can be opened using NOTEPAD.EXE or WORDPAD.EXE. *.LOG (log file). This is a text file and can be opened using NOTEPAD.EXE or WORDPAD.EXE. *.RAW: The raw data file. This is in binary format and cannot be opened by the user.

Data Storage	<p>Individual readings</p> <p>Raw 6 sample per second readings (when enabled)</p> <p>Notes</p> <p>Calibration parameters</p>
Station Designation System	<p>Multiple station designation systems are supported:</p> <ul style="list-style-type: none"> • NSEWm (Line 100N, Station 20S) • NSEWft (Line 100N, Station 20S) • XYm (Line 100, Station -20) • XYft (Line 100, Station -20) • UTM (Easting 548906E, Northing 5432145S) • LAT/LONG (Longitude 49E 50' 34", Latitude 12N, 13', 22") (GPS)
Near Terrain Corrections	<p>Hammer chart type graphic data entry</p> <p>Automatic correction</p>
Remote Control	<p>All parameters accessible</p> <p>Via Cable RS 232 only</p> <p>System can be reset remotely</p>
Smart Battery Status	<p>True capacity level</p>

Reference

Software Specifications

SCTUTIL	Windows based GUI Data dumping via RS 232 and USB Processing of data formats as described in software specifications Operating system uploading USB drivers provided
CG5REMOTE	Windows based GUI Control of all parameters On-line, Off-line data acquisition RS-232 Cable

Standard Accessories

Tripod	Gravity meter tripod with built-in bubble level 0.5 kg
Battery	Two 11.1V Smart batteries
External Battery Charger	115/230V AC; 50/60 Hz for plugging in Smart batteries externally
Power Adapter	90/264V AC; 50/60 Hz for direct connection to Autograv
Communications	RS-232 cable, adapter, USB cable and SCTUTIL software
RS-232C Cable and Adaptor	Includes a special RS-232C data transfer cable and adaptor for communicating with peripheral devices.
USB Cable	Includes a special USB cable for communicating with peripheral devices.
Operations Manual	

Optional Accessories

Belt Battery Pack	The operator wears the Belt Battery Pack inside their coat during cold weather to keep rechargeable batteries warm. This extends the lifetime of the batteries.
Chart Recorder Cable	This cable interfaces with any standard chart recorder.
High Temperature Option	For operating up to +55°C.
Low Temperature Option	For operating up to +35°C.
Elevation Options	Scintrex can provide a variety of options for elevation and positional control.
External Battery Charger	AC charger for charging the Smart batteries without hooking up to the Autograv.
Peripheral Devices	Scintrex can recommend and supply suitable digital printers, microcomputers, modems and other peripherals.

Application Software

Scintrex can supply fully documented software.

This software permits:

- data reduction
- archiving of data
- processing of data
- profile and contour modeling
- modelling

Training

Scintrex can provide detailed training programs for the CG-5 including operation, basic maintenance and data processing.

Instrument Parts List

CG-5 Meter and Standard Accessories

Item Description	SCINTREX Part Number
CG-5 Gravity Meter (includes:)	867000
Autograv Meter	867010
Tripod	867015
2 Smart Batteries	400061
Smart Battery Charger	400209
RS-232C Cable	745081
USB Cable	735532
Carrying Bag	867016
SCTUTIL - data dump and operation system upgrade	735650
GPS Antenna	867024
CG-5 Information Package, including Operation Manual and High Precision Gravity Guide	867700
Transit Case	867017

Reference

Options

Item Description	SCINTREX Part Number
CG-5 Remote Control Option	867760
Chart Recorder Cable	
Smart Battery	400061
Battery Pack Belt	867450
CG-5 Tripod extension	867209
Smart Battery Charger	400209



Remote Operation of the CG-5

For operators who want to deploy the system remotely, the CG-5 enables a cable mode of remote operation.

This section describes the basic principles required to operate the system remotely. For detailed instructions on how to complete specific parameters in the displayed screens, users should refer to Chapter 1, “Getting Started” which provides an overview of system screens and parameters.

Setting Up for Remote Operation

The basic requirements for operating remotely are to install the CG5Remote software and then link via RS-232 to the CG-5. More details are provided below:

Enabling the remote password

The CG-5 Remote option requires a password. This password is obtained by communicating with the Customer Service Department of Scintrex Limited.

PRESS



Press the SETUP key. The following screen is displayed:

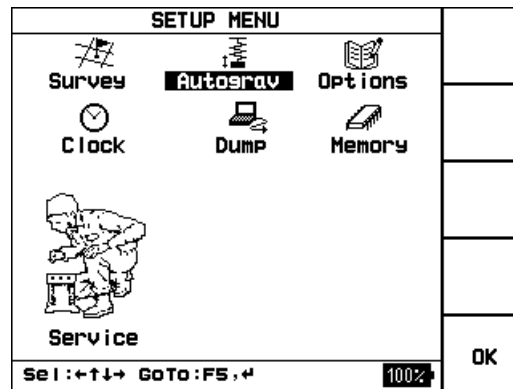

To access the SERVICE screen:

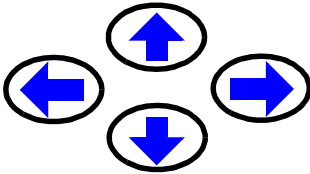

In the set-up screen, *press* the arrow keys to bring the cursor to the service icon.

The word Service is highlighted, as illustrated below.

Service

PRESS



Press the F5 <or ENTER> key. The following screen is displayed:

SERVICE MENU	
Service and support	REMOTE
Software upgrade	PWORD
Calibration: OFF	
Enable factory tests	
	OK
Select:↑↓ GoTo:Enter Exit:F5	

PRESS



Press the F1 key to enter your password.

Remote

Installing the CG5 Remote Software

Start by placing the CG5REMOTE CD-ROM in your drive. The Autostart routine is initiated and the following screen is displayed.

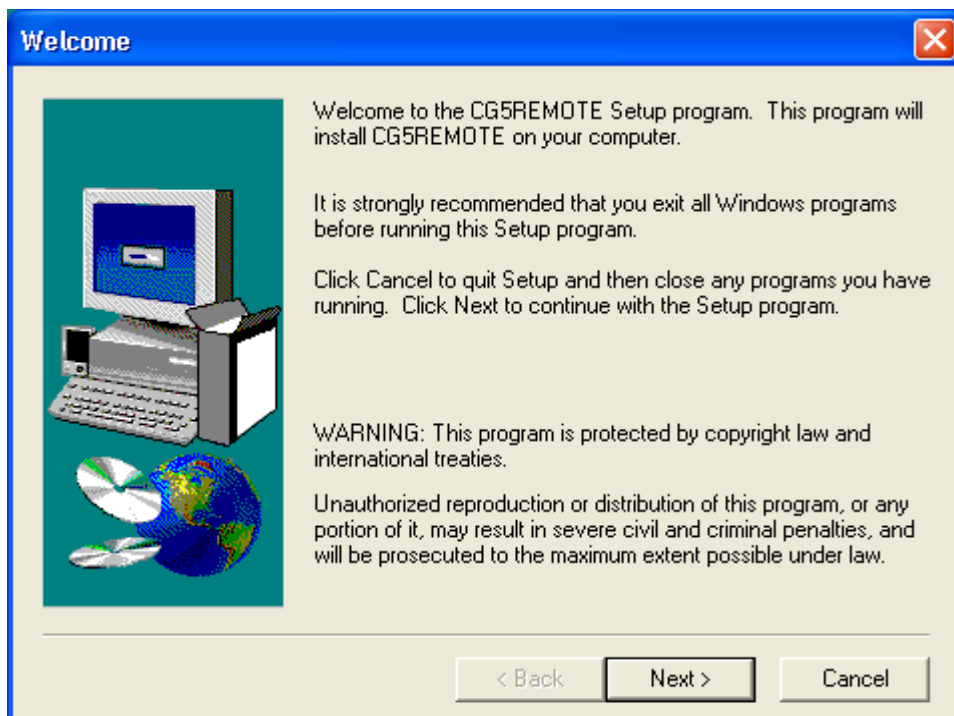

Press the <Next> button to advance to the next screen.

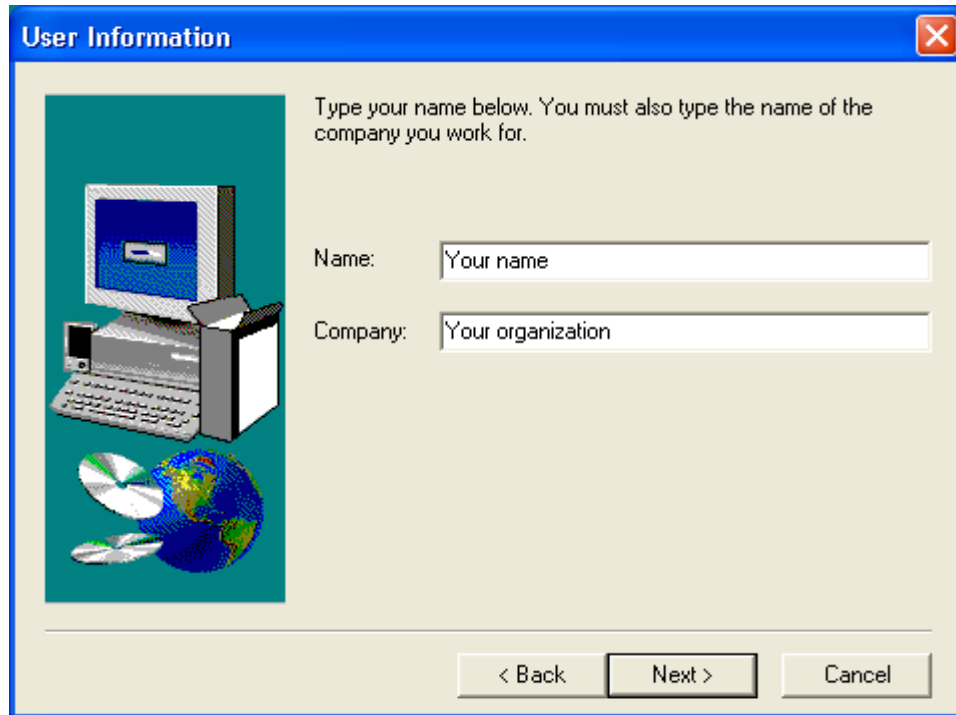

Remote

Enter your name and the name of your organization, and **press** the <Next> key. The system displays the following screen.

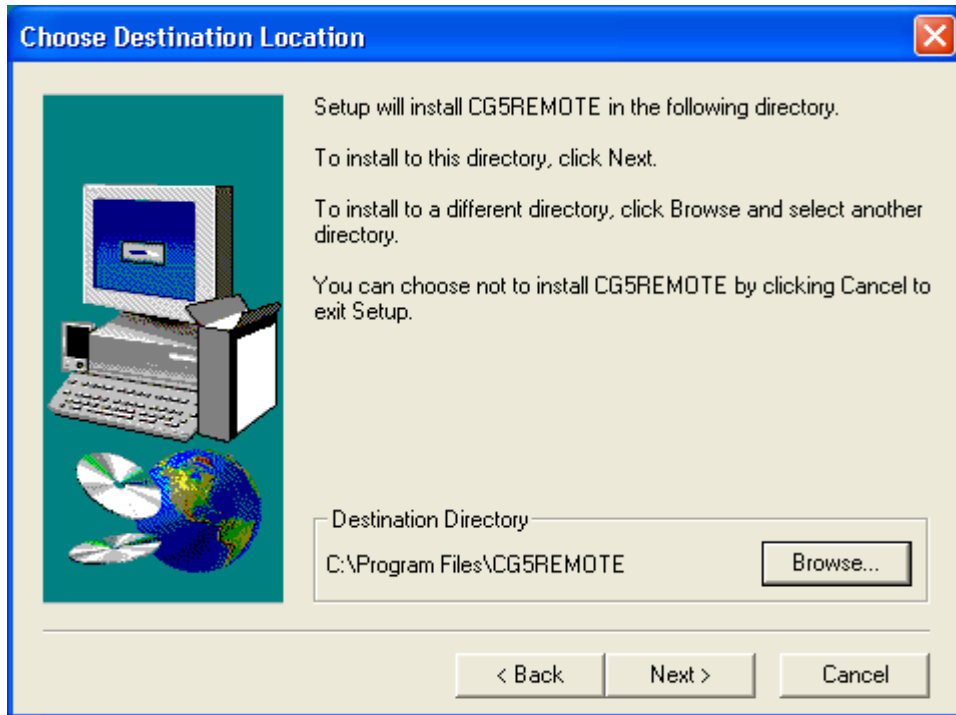

Use the **Browse** button to select a name for the destination directory into which you want to install the software. When finished, **press** the <Next> button. The system displays the following screen.

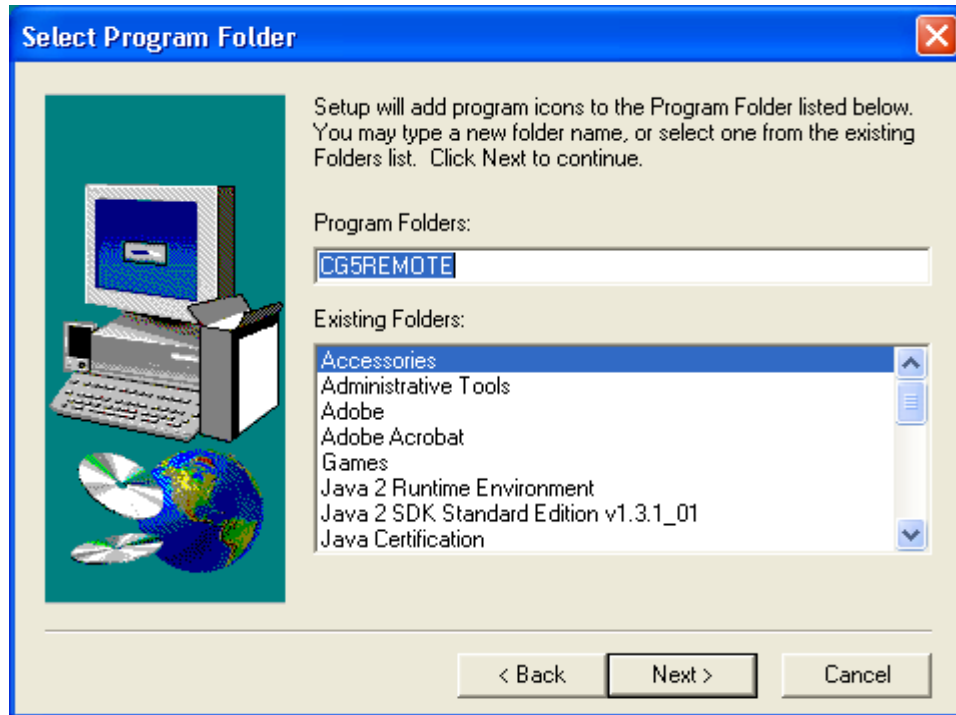

Remote

Define a folder name for adding program icons and **press** the <Next> key. The system displays the following screen.

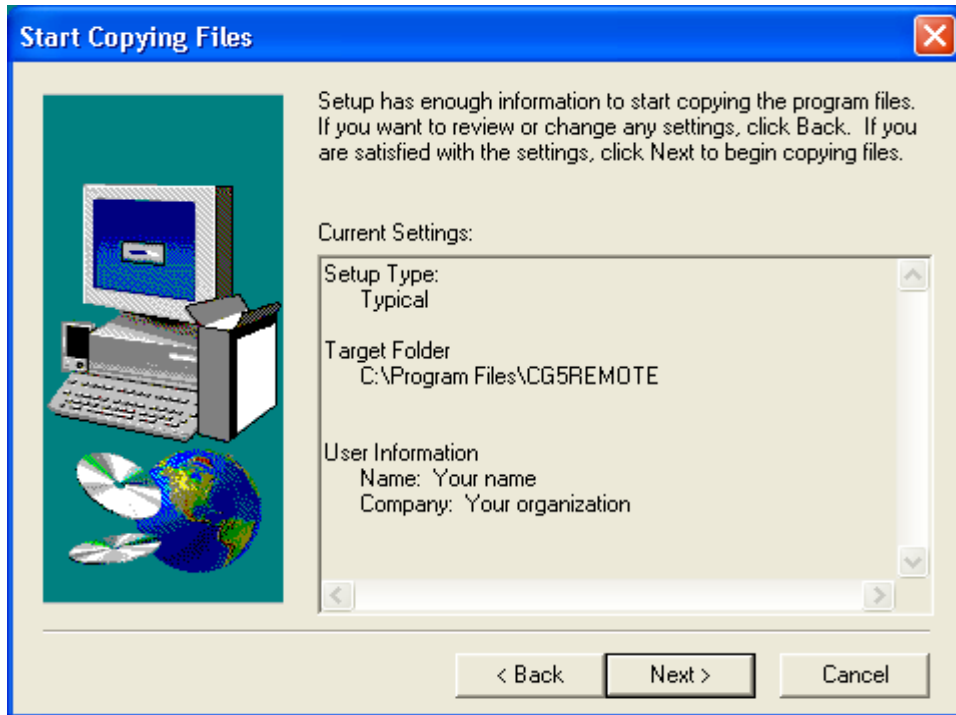

If you are satisfied that the current settings are correct, *press* the <Next> key. If you want to change any information *press* the <Back> key. The installation is complete.

Double-click on the program icon. The system displays the following screen.

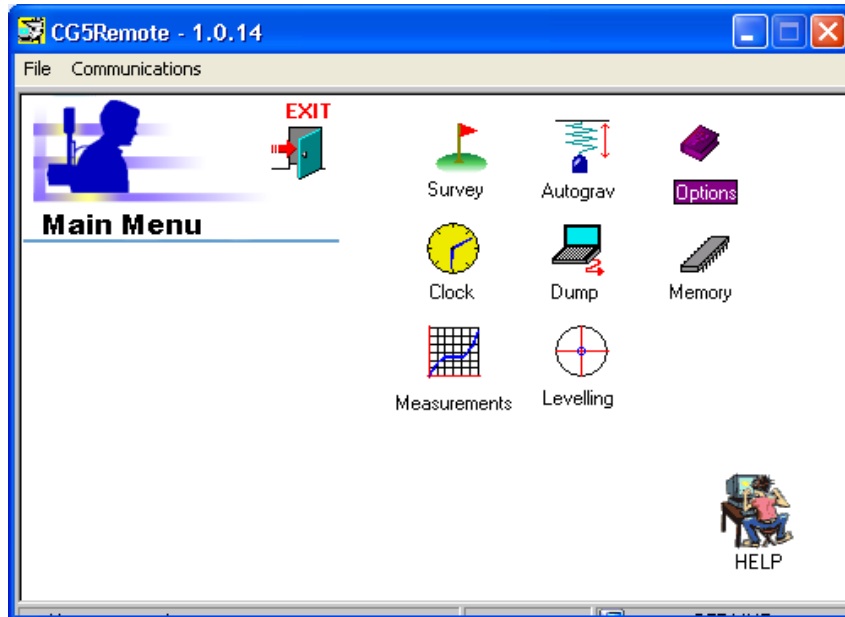

This is the main screen used for operating the CG-5 Autograv in its Remote configuration.



Note:

As you walk through the following examples, note that the system parameters are identical to the ones described in Chapter Chapter 2, “Setting Up Your Instrument.” For details, please refer to this chapter and the appropriate topics (ex. “Using the Options Screen” on page 2-18).

Starting CG5REMOTE and Linking to the Autograv

The process for acquiring data remotely includes the steps below. This process assumes that you are using a RS-232 serial connection as your communication mode:

Attach your RS-232 cable to your Personal Computer and to the Autograv.

Turn the Autograv on.

Run the CG5REMOTE program and **select** the Communication menu in the CG5REMOTE screen. The system displays the following drop-down menu:

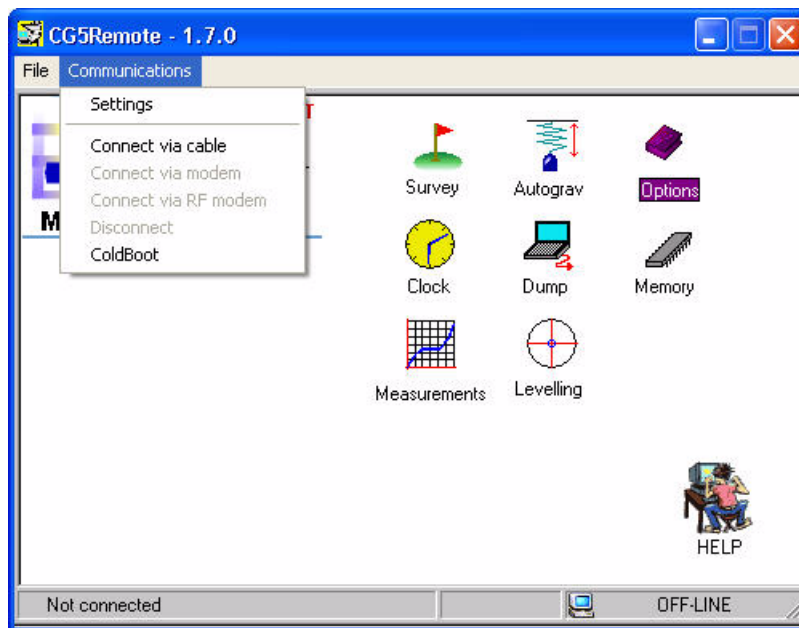

Select the Connect via cable option. The CG-5 displays a “Remote On ... CG-5 Device OK” message.

Your Personal Computer also displays a message indicating that the system is connected.

You are now ready to configure the system.

Configuring Survey Settings

To configure your Survey settings, *select* the Survey icon in the CG5REMOTE screen. The system displays the following screen

Survey Header	
Survey ID:	Default
Customer:	Default
Operator:	Default

Grid Reference	
Longitude:	79.6E
Latitude:	43.9N
Azimuth:	0
Elevation:	0
UTM Zone:	0
GMT Diff:	5

Remote

Type a unique survey identifier and other parameters (optional).

If you want to specify a Station Designation System as well, *press* the Station Designation button. The system displays the following screen.

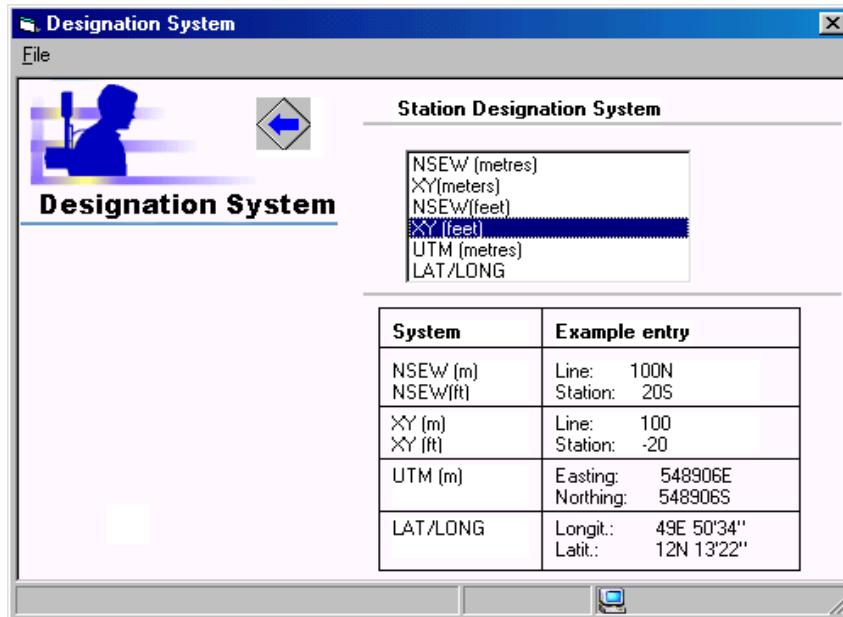

Use your mouse to *select* the system that you would like to use. The location can be specified in one of six station designation systems.



Note:

Use LAT/LONG when the CG-5 is equipped with the GPS option.

When finished, *press* the left arrow key. The system returns you to the Survey Header screen.

To exit and save your settings, *press* the left arrow key a second time.

Configuring Autograv Settings

To configure your Autograv settings, *select* the Autograv icon in the CG5REMOTE screen. The system displays the following screen.

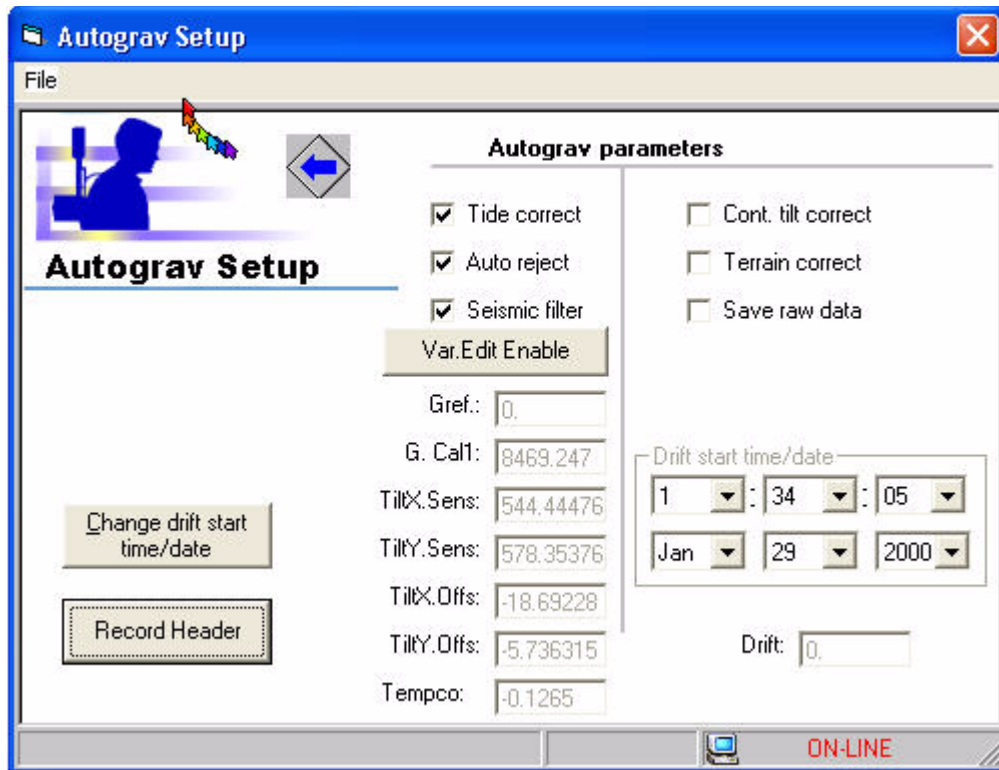

Remote

Select any corrections that you would like to apply. Generally, you will not need to adjust the values that appear below the corrections unless you are performing regular maintenance. For details on maintenance, please refer to Chapter 5, “Maintaining and Trouble-shooting Your System”.

You can also change the Drift start time and date. Before you proceed with this step, you may want to set the Clock on the Autograv (see below) as this is the value to which the drift time is set automatically when you press the Drift/start time/date button.

When finished setting Autograv parameters and initializing the drift, if required, **press** the Record Header button. All changes are saved.

To exit from this option, **press** the left arrow key. The system returns you to the Survey Header screen.

To exit and save your settings, **press** the left arrow key. The system returns you to the CG5REMOTE screen.

Configuring Options

To configure system Option settings, select the Options icon in the CG5REMOTE screen. The system displays the following screen.

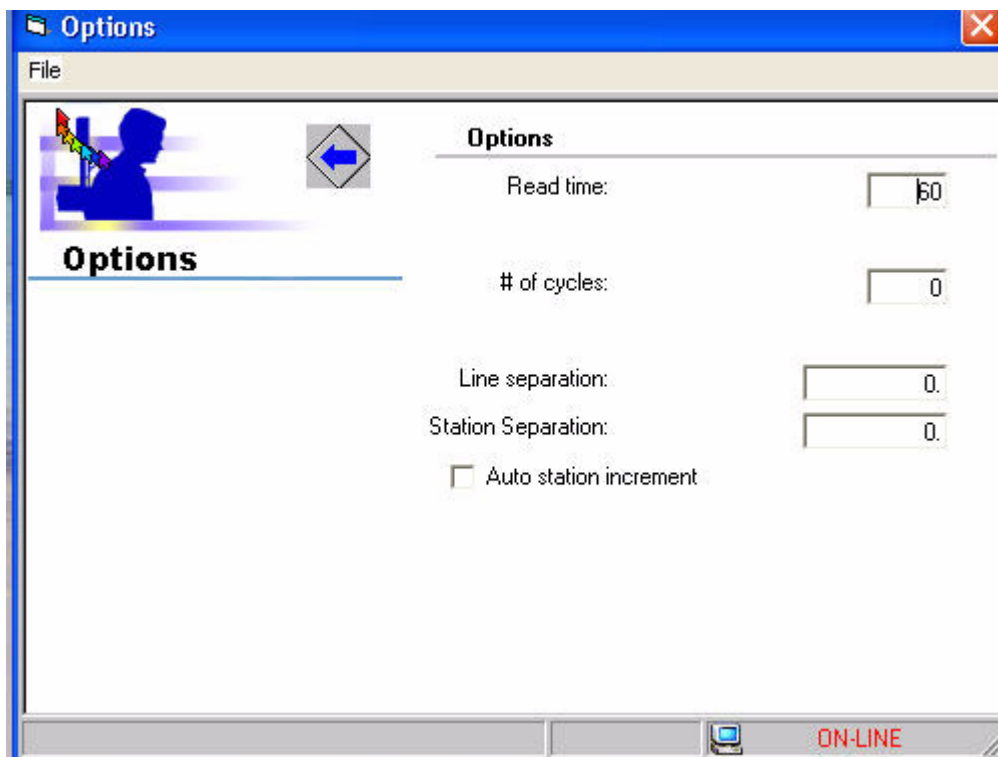

This screen enables you to specify read and cycling times, and other parameters. **Type** values, such as the reading time, directly into the fields shown in the Options screen.

To exit and save your settings, **press** the left arrow key. The sysem returns you to the CG5REMOTE screen.

Setting the CG-5 Clock

To configure your Clock settings, select the Clock icon in the CG5REMOTE screen. The system displays the following screen.

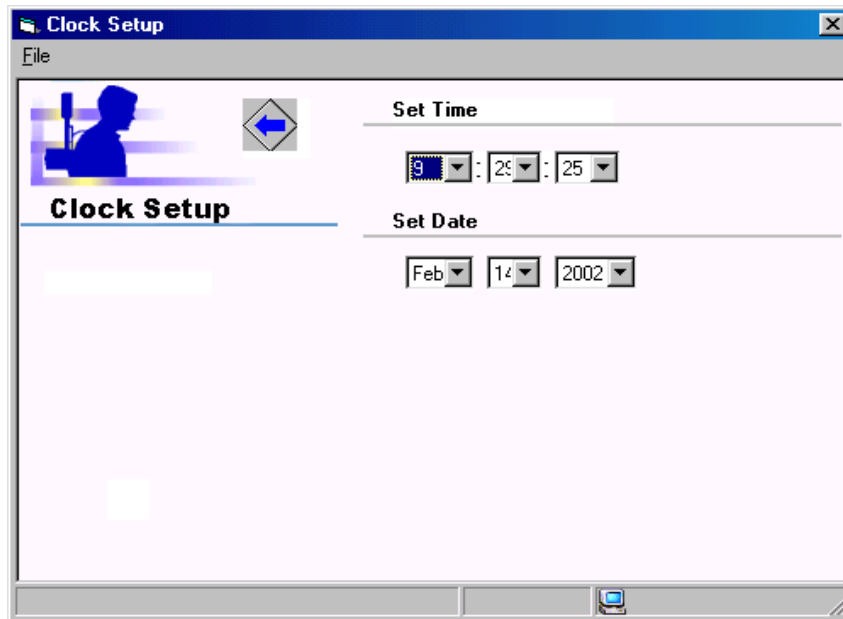

This screen enables you to change your date and time for the CG-5. *Type* new date information directly into the fields shown in the Clock screen.

To exit and transfer your settings to your CG-5 unit, *press* the left arrow key. The system returns you to the CG5REMOTE screen.



Note:

The HH, MIN, SEC, MON, DAY and YEAR fields must be selected in order to be updated in the CG-5 unit. *Tab* through the field that you would like to synchronized to on the unit.

Measuring Data

The data measuring process consists of leveling and measuring. Following a survey, you will also want to dump data and erase memory to enable acquisition of additional measurements.

Leveling the Instrument

To level the CG-5, *select* the Leveling icon in the CG5REMOTE screen. The system displays the following screen:

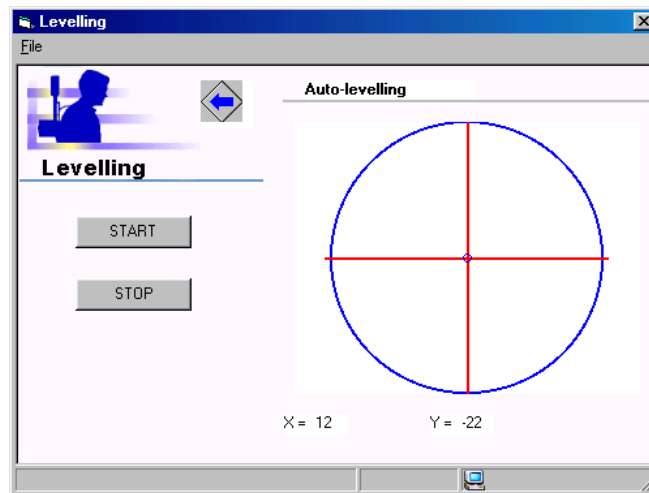

This screen enables you to automatically level the system. To initiate this process, *press* the Start key.

When leveled within survey specifications, *press* the Stop key.

To exit and set up for actual data measurement, *press* the left arrow key. The system returns you to the CG5REMOTE screen.

Recording Data

To measure data with the Autograv, select the Measurement icon in the CG5REMOTE screen. The system displays the following screen.

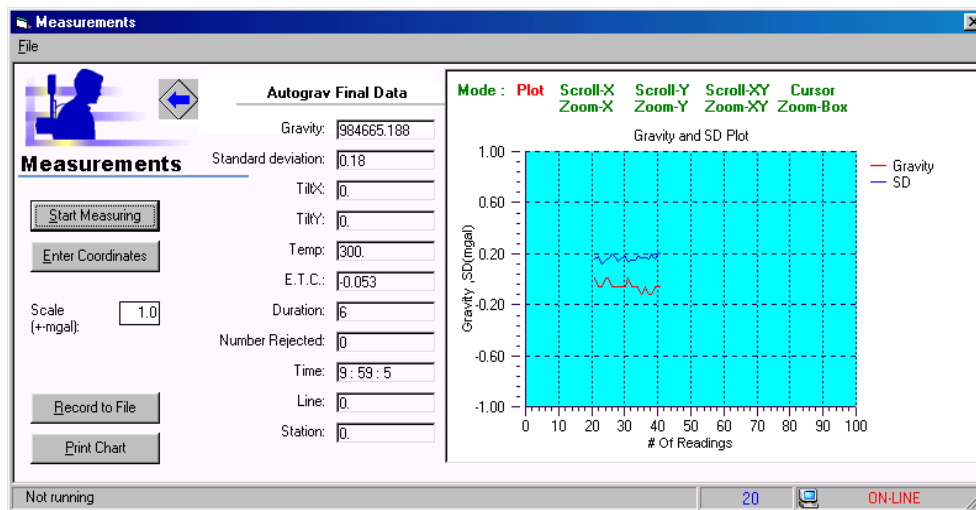

This screen enables you to start the measurement process on the CG-5 remotely and to display data directly to your Personal Computer. To initiate this process, *press* the Start Measuring key.



Note:

On the CG-5, you will notice that the instrument starts reading data. It first displays a strip chart recorder screen followed by the Autograv Final Data screen which shows numeric values for gravity, standard deviation and other parameters.

Watch your Personal Computer to monitor the data as it is displayed on your system. Gravity and standard deviation are the key parameters plotted in the strip recorder display. Numeric values are displayed to the left of the strip recorder.

To stop measurement, **press** the Stop Measuring button. The system changes the name displayed on the button to “Start Measuring” to indicate that the system is no longer recording data.

To re-start measuring, **press** the Start Measuring button.

If you want to exit, **press** the left arrow key. This leaves the CG-5 in active measuring mode until later when you want to stop the measuring process and download data. Alternately, you may want to generate output as described below.

Generating Output

Several types of output can be obtained immediately. These include a text (*.txt) file and a strip chart.

To generate a text file, **press** the Text file button. The system displays the following screen

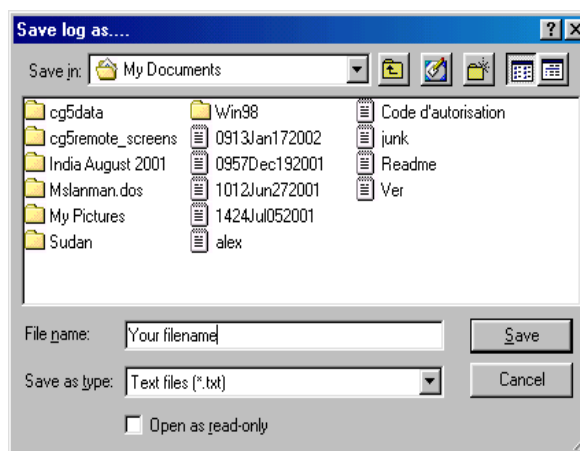

Enter the file name and **press** the Save key. The data is saved to your Personal Computer.

To print a chart, connect a printer to your Personal Computer and **press** the Print Chart key. The system displays the following screen.

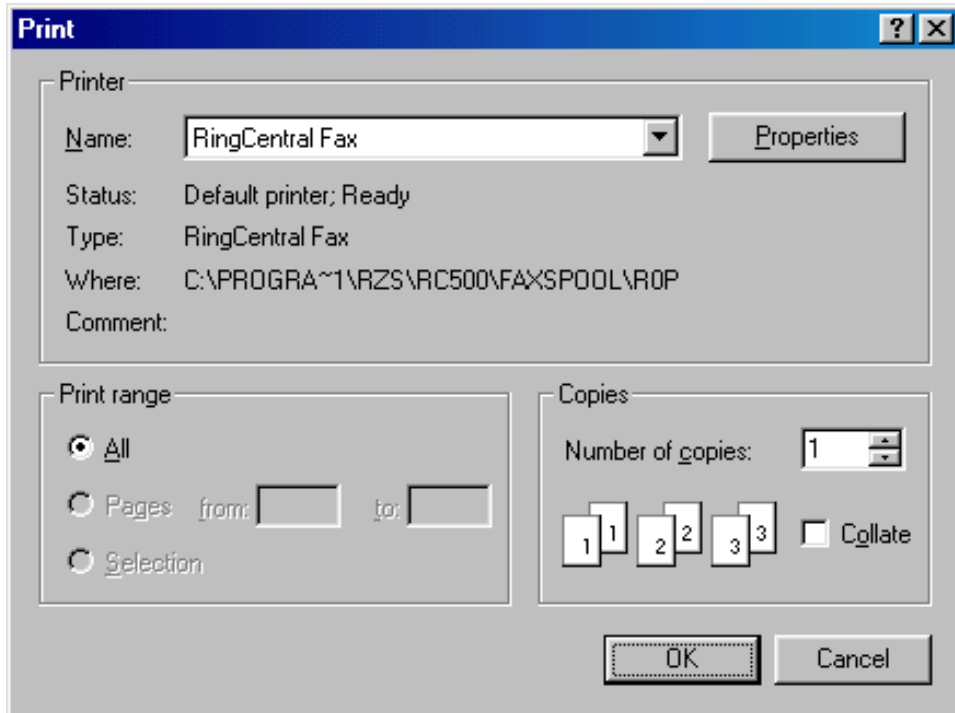

Note that data can be printed to any device that is connected to your system, such as a printer or fax machine, etc.

Dumping Data

To dump data from the CG-5, select the Dump icon in the CG5REMOTE screen. The system displays the following screen.

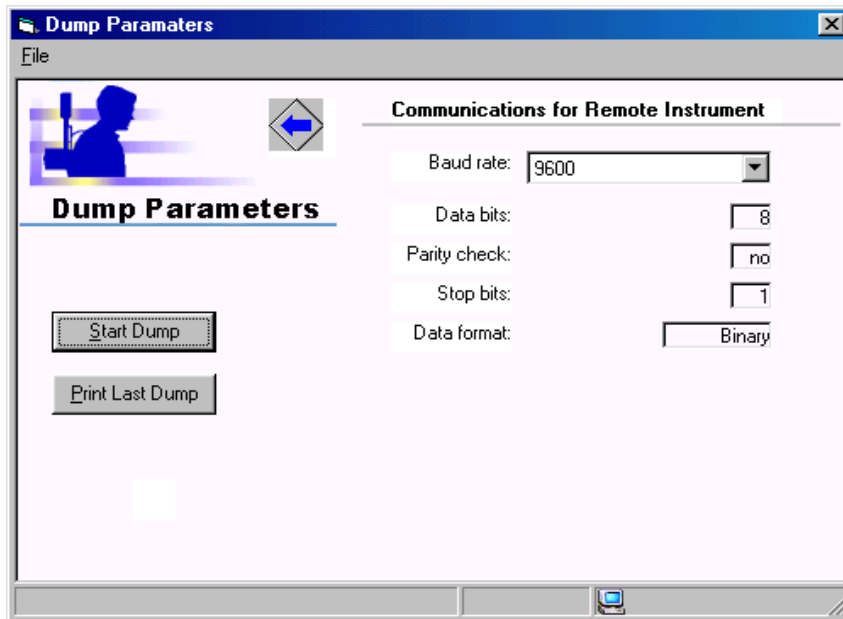

This screen enables you to automatically dump data to your system. To initiate this process, *press* the Dump key.

The system prompts you to enter a file name in Scintrex Geophysical Database (*.SGD) format. Enter a name and *press* the OK key.

The CG-5 displays a “Dumping Data” message and a corresponding message is shown on your Personal Computer screen. When finished, you see a message. You can now manipulate your data as required.

To exit from the Data Dumping option, *press* the left arrow key. The system returns you to the CG5REMOTE screen.

Erasing Memory

As you acquire measurements, you will want to periodically check the memory and ensure that there is enough space available for future measurements. If not, you can dump data and erase the memory.

To check or erase the Autograv memory, *select* the Memory icon in the CG5REMOTE screen. The system displays the following screen.

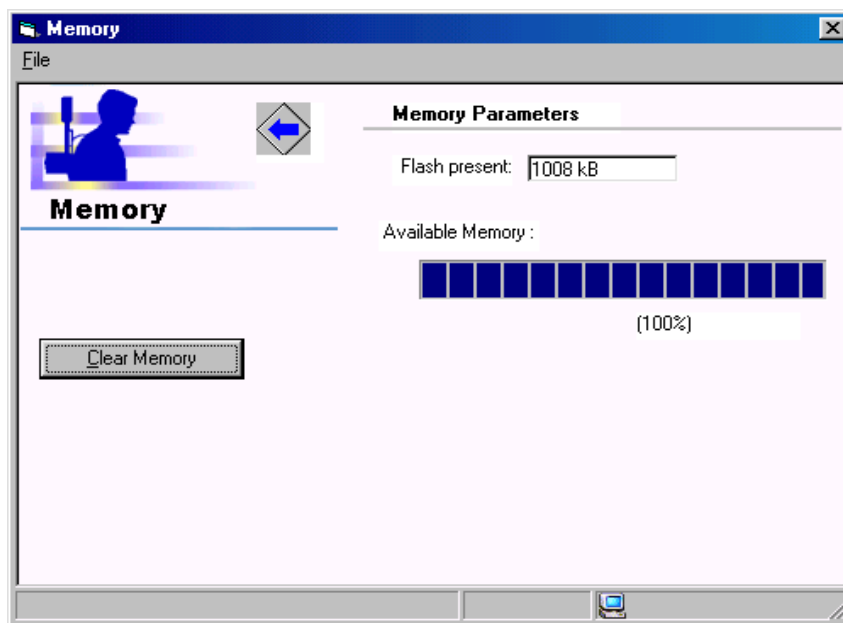

This screen enables you to view the memory available for recording data and to clear the Flash memory. To initiate this process, *press* the Clear Memory button. The CG-5 shows a status bar that shows the progress of the memory clearing process. You also see a copy of this status bar on your Personal Computer.

When completed, the system displays a "Memory Erased" message on your Personal Computer screen. *Press* the OK key to remote this message from your screen.

To exit from the Memory option, *press* the left arrow key. The system returns you to the CG5REMOTE screen.

Disconnecting

When all of your configuration and measurement steps are complete, the final action to take is to disconnect the communications with the CG-5. To do this, access the Communications menu in the main screen and *select* the Disconnect option.

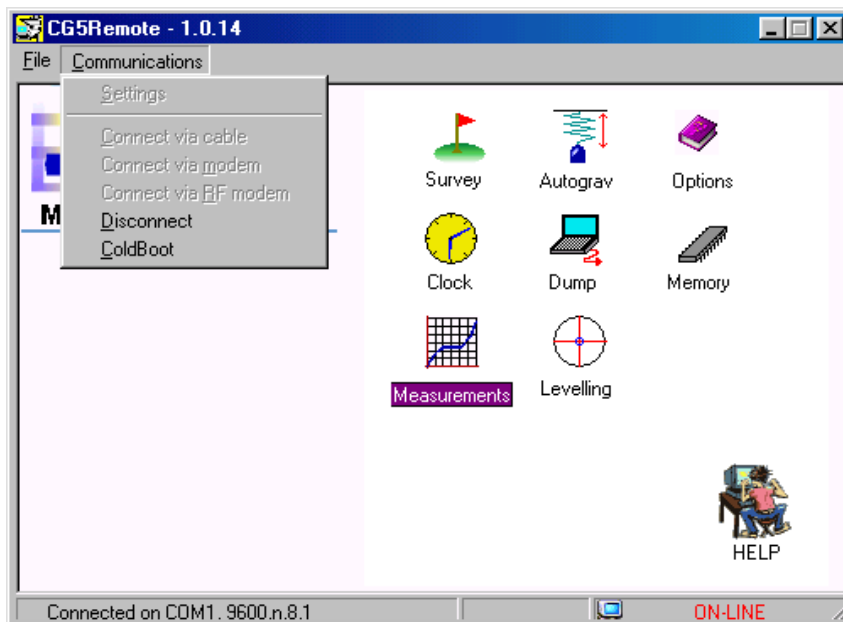

Remote

The system will now operate remotely until such time as you want to access the system again and download data, etc.

Note that the Cold Boot option enables you to disconnect regardless of what state the CG-5 is in and to re-set the system to its default settings. You can either use these settings or re-set them following a cold boot.



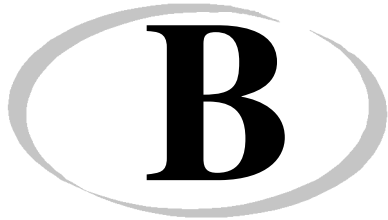

Theory of Operation

System Overview

The sensing element of the Autograv is based on a fused quartz elastic system. The gravitational force on the proof mass is balanced by a spring and a relatively small electrostatic restoring force. The position of the mass, which is sensed by a capacitive displacement transducer, is altered by a change in gravity. An automatic feedback circuit applies DC voltage to the capacitor plates producing an electrostatic force on the mass which brings it back to a null position.

The feedback voltage, which is a measure of the relative value of gravity at the reading site, is converted to a digital signal and then transmitted to the instrument's data acquisition system for processing, display and storage.

The inherent strength and excellent elastic properties of fused quartz together with limit stops around the proof mass permit the instrument to be operated without clamping. Further protection is provided by a durable shock mount system which attaches the sensor to the housing.

The parameters of the gravity sensor and its electronic circuits are chosen so that the feedback voltage covers a range of over 8000 mGals without resetting. The use of a low-noise electronic design, together with a highly accurate auto-calibrating analog to digital converter, results in a resolution of 0.001 mGal, equipping the gravity meter for both detailed field investigations and large scale regional or geodetic surveys.

The instrument's tilt sensors are also electronic, with a resolution of 1 arc second. The outputs from the sensors are displayed on the instrument's front panel and also transmitted to the data acquisition system where they are displayed and stored. If the instrument is operated on an unstable base, real-time corrections for tilt errors can be automatically made over a range of ± 200 arc seconds.

Protection from ambient temperature changes is provided by locating the quartz elastic system, the analog to digital converter, sensitive electronic components and the tilt sensors inside a high-stability, two stage, thermostatically controlled environment. There is no mechanical temperature compensation. External temperature changes are reduced by a factor of over 1×10^5 and small residual effects are corrected in software using the output of a sensor located in close thermal contact with the main spring.

The operating range of the thermostat in the standard instrument is -40°C to $+45^\circ\text{C}$. However, since there is no critical operating point for the sensor, the upper operating temperature can be set at a lower or higher value (optional -45°C).

The entire gravity sensing mechanism is enclosed in a vacuum chamber. Since there are no mechanical feed-throughs, excellent isolation from variations in atmospheric pressure is obtained. This extremely stable operating environment for the quartz elastic system allows the long-term drift of the sensor to be accurately predicted, and real-time software correction reduces it to less than 0.02 mGals/day.

The sensor design is mechanically very simple. The fine balancing required to obtain astatisation is not needed, as the displacement transducer has sufficient resolution (0.02nm) to detect the beam position of a non-astatised system, and electronic filtering reduces the effect of seismic noise.

The mechanisms, micrometer screws, gearboxes and mechanical feed-throughs associated with mechanical feedback systems have been replaced by a voltage applied to the same plates which form the displacement transducer. The temperature control is also accurate enough for the sensor to operate without mechanical compensation.

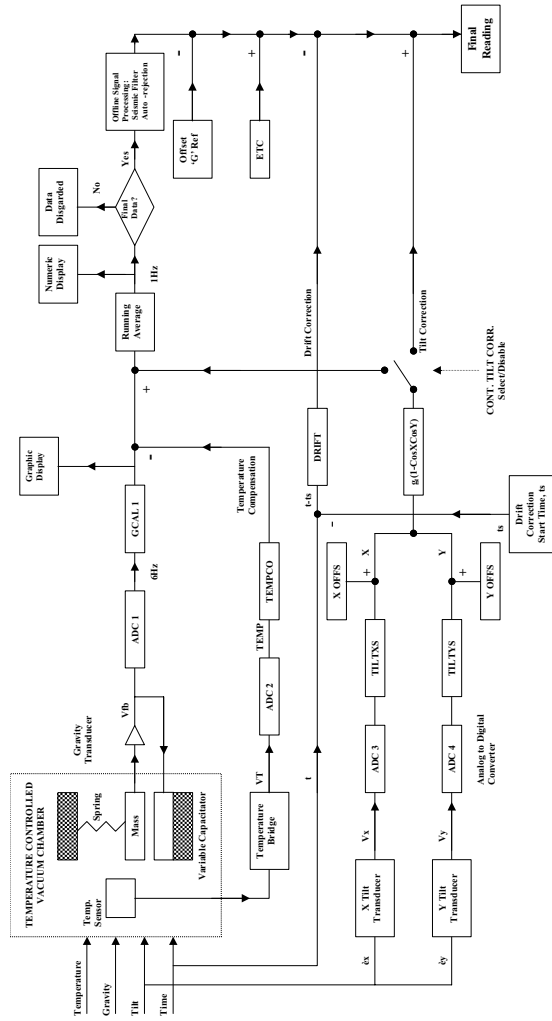

Autograv Block Diagram of Signal Flow

Figure B-1 - Autograv Block Diagram of Signal Flow

Theory

Control Console and Software

The control console includes:

- 27-key dual function keypad
- 320 X 240 quarter VGA monochrome graphics scree
- microprocessor
- solid state memory

Console Functions: —

It processes and applies corrections to the signals from the sensor, stores data, formats it for outputting and performs instrument control functions. A menu format with prompts is used to operate the instrument.

Operating Modes: —

The gravity meter has three modes of operation:

- **Field or Reading** mode, where readings are initiated by the operator
- **Auto Repeat**, where the number of readings is preset by the user.

The software function is essentially the same in all modes.

Console Operation—

The control console operation is based on a one-second gating time. Once every second:

- analog signals are sampled
- the display is updated
- keypad commands are responded to
- necessary control functions performed

During a reading:

- the gravity signal V_{fb} is sampled six times every second by ADCL (see Figure B-1 on page B-3).
- the individual samples are averaged to filter out seismic noise.
- a running mean of the samples is displayed together with its standard deviation.
- the system applies a self-calibrating ADC
- corrections for tilts and long-term drift are made every five seconds during the reading.

-
- a statistical rejection criterion is used to discard any noise spikes.
 - a tide and temperature correction is applied at the end of the reading.

When a measurement is completed, the gravity reading is stored in the memory along with the following nine other variables:

1. station number
2. standard deviation of the mean of the five 5-second samples
3. tilt X
4. tilt Y
5. sensor temperature
6. tide correction applied
7. reading duration
8. number of rejected samples
9. time of start of reading
10. terrain correction applied
11. raw data if enabled.

All current and stored data can be viewed on the VGA screen by using the RECALL feature on the keypad.

Additional information can be entered by way of notes at the time of measurement for recording in memory.

The Flash memory stores approximately 200000 readings as defined in Chapter 6, “Reference Information”. The memory is protected against battery failure.

Other information is also generated and is accessible through the display, including time, date, setup parameters and CG-5 options.

The instrument is equipped with RS-232 and USB interfaces. This enables data from the memory to be accessed through a connector on the instrument front panel.

Spring Service Life and Reading Range

The uncorrected gravity reading is obtained as shown from Equation (B.4) on page B-9. The gravity reading range has high and low end, the range of which is guaranteed to be 8000 mGals, but is normally much larger. The low end of the gravity measurement range of the CG-5 may be calculated by inserting value (SF/SC) = 0.1 into Equation (B.4)

$$SU_{\min} = 0.1 * GCAL1 + 0.01 * GCAL2 \quad (B.1)$$



Note:

GCAL2 has been permanently set to zero in the CG-5 instrument.

The average value Of SU_{\min} is about 600 mGal. Depending on the values **GCAL1 and GCAL2**, this value may differ somewhat for your meter. It is recommended that you calculate this value for your meter, because the gravity readings of lower values than SU_{\min} may not be accurate.

The high end of the gravity measurement range may be calculated by inserting value (SF/SC) = 1.457 into Equation (B.4)

$$SU_{\max} = 1.457 * GCAL1 + 2.123 * GCAL2 \quad (B.2)$$

The average value of SU_{\max} is about 12000 mGal. Depending on the values **GCAL1 and GCAL2** this value may differ somewhat for your meter. It is recommended that you calculate this value for your meter, because the gravity readings of the higher value than SU_{\max} may not be accurate.

The CG-5 sensor spring position is adjusted during the sensor manufacture in such a way that, on average, the gravity reading in Toronto (latitude 43.7 degrees) is about 4200 mGal. This, in conjunction with the gravity reading range of about 8000 mGals, assures that a newly produced CG-5 may measure the relative gravity anywhere on the surface of the earth, from elevations of a few thousand meters above the equator to sea levels at both poles. For your convenience, values of normal gravity at sea level, as a function of latitude, are listed in Table 1 on page B-8.

Because of the positive drift rate of the CG-5 gravity sensor, the uncorrected gravity readings at the fixed locations gradually increase in value. The linear drift of the CG-5 sensor is caused by an unavoidable creep of the quartz spring, whose length under tension increases, on the average, by 0.5 ppm/day at the operating temperature of 60°C. A typical sensor with the drift rate of 0.5 mGal/day will reach the high end of the measurement range, at the latitude of 60 degrees, in about 20 years. If used at lower latitudes, as most gravimeters are, the typical CG-5 service life will be even longer.

You may estimate the remaining service life of your meter in the following way:

1. Calculate the value SU_{max} for your meter.
2. Obtain the gravity reading at your location.
3. If you are planning to use your meter at higher latitudes than your present latitude, evaluate from Table 1 the gravity difference between your present latitude and the highest latitude at which you will be using your meter. Add this difference to the reading obtained in Step 2. to obtain the value SU_m .
4. The remaining service life expressed in days is calculated by dividing the difference ($SU_{max} - SU_m$) by the value of the linear drift rate of your CG-5.

Example:—

1. You have calculated for your meter from Equation (B.2) on page B-6:
 $SU_{max} = 8800$ mGal
2. The drift rate of your meter is: 0.51 mGal/day.
3. Assuming that you are at latitude of 50°.
4. You have measured $SU = 5012$ mGal.
5. Assuming that you will be using your meter up to latitudes of 60°.
6. Giving $SU_m = (5012 + 847)$ mGal, (see Step 3.).
7. Then the number of remaining service days is: $(8800 - 5012 - 847)/0.51 = 5767$.

$$g = g_e \cdot [1 + b \cdot \sin^2 2q] - [b_1 \cdot \sin^2 2q] \quad \text{gravity at latitude } q \quad (\text{B.3})$$

where:

$g_e = 978.03268$ (Gal), gravity at the equator

$b = 0.00503244$

$b_1 = 0.0000058$

q = latitude

Table 1: Normal Gravity at Sea Level (Torge, 1989 p.51)

Lat. θ	g (Gal)	$g - g_e$ (mGal)	Lat. θ	g (Gal)	$g - g_e$ (mGal)	Lat. θ	g (Gal)	$g - g_e$ (mGal)
0	978.032680	0.000	30	979.324915	1292.235	60	981.917895	3885.215
1	978.034253	1.573	31	979.403907	1371.227	61	981.995650	3962.970
2	978.038969	6.289	32	979.484390	1451.710	62	982.071737	4039.057
3	978.046823	14.143	33	979.566266	1533.586	63	982.146062	4113.382
4	978.057805	25.125	34	979.649436	1616.756	64	982.218535	4185.855
5	978.071902	39.222	35	979.733799	1701.119	65	982.289066	4256.386
6	978.089098	56.418	36	979.839254	1786.574	66	982.357569	4324.889
7	978.109371	76.691	37	979.905696	1873.016	67	982.423960	4391.280
8	978.132697	100.017	38	979.993021	1960.341	68	982.488156	4455.476
9	978.159048	126.368	39	980.081122	2048.442	69	982.550080	4517.400
10	978.388392	155.712	40	980.169892	2137.212	70	982.609654	4576.914
11	978.220695	188.015	41	980.259224	2226.544	71	982.666806	4634.126
12	978.255916	223.236	42	980.349009	2316.329	72	982.721465	4688.785
13	978.294015	261.335	43	980.439138	2406.458	73	982.773564	4740.884
14	978.334944	302.264	44	980.529500	2496.820	74	982.823038	4790.358
15	978.378655	345.975	45	980.619987	2587.307	75	982.869828	4837.148
16	978.425095	392.415	46	980.710488	2677.808	76	982.913875	4881.195
17	978.474208	441.528	47	980.800892	2768.212	77	982.955125	4922.445
18	978.525935	493.255	48	980.891089	2858.409	78	982.993526	4960.846
19	978.580214	547.534	49	980.980970	2948.290	79	983.029033	4996.353
20	978.636978	604.298	50	981.070424	3037.744	80	983.061600	5028.920
21	978.696160	663.480	51	981.159343	3126.663	81	983.091188	5058.508
22	978.757689	725.009	52	981.247618	3214.938	82	983.117761	5085.081
23	978.821489	788.809	53	981.335140	3302.460	83	983.141285	5108.605
24	978.887485	854.805	54	981.421804	3389.124	84	983.161732	5129.052
25	978.955596	922.916	55	981.507502	3474.822	85	983.179075	5146.395
26	979.025740	993.060	56	981.592131	3559.451	86	983.193295	5160.615
27	979.097832	1065.152	57	981.675586	3642.906	87	983.204373	5171.693
28	979.171785	1139.305	58	981.757765	3725.085	88	983.212296	5179.616
29	979.247510	1214.830	59	981.838568	3805.888	89	983.217053	5184.373
30	979.324915	1292.235	60	981.917895	3885.215	90	983.218640	5185.960

If, after many years of service, your CG-5 has drifted out of range, then the spring position may be reset by a routine procedure at the Scintrex plant.

Processing of the Gravity Signal

While reading this section, please also refer to the Signal Flow diagram on page B-3.

The input to the gravity analog to digital converter (ADCL) is switched between V_{fb} , the gravity transducer output and V_{cal} , the stable calibration voltage.

** When the instrument is in the SETUP mode (after the SETUP key is pressed once), the calibration voltage is connected to ADCL. In this mode, the value of V_{cal} can be viewed on the display under the heading G R AV.

** In the READ mode, (after the MEASURE CLR key is pressed) the input to ADC 1 is held at V_{cal} for one second (during P A U S E) then switched to V_{fb} for x one-second samples. It is then switched back to V_{cal} for one sample then to V_{fb} for x samples and so on until the reading is terminated. The value of x is entered under the Autograv setup at the CAL AFTER prompt. The output of ADC 1 is termed SC when V_{cal} is applied and SF when the V_{fb} is applied.

Uncorrected sample—

The calibration voltage and other calibration factors are then applied to the gravity signal by the function f_{cal} in order to give an uncorrected sample

$$SU = f_{cal}(SC, SF) = GCAL1 \left(\frac{SF}{SC} \right) + GCAL2 \left(\frac{SF}{SC} \right)^2$$

(B.4)

SF is divided by the most recent value of SC to correct for any drift in the scale factor of ADC1. The factors $GCAL1$ and $GCAL2$ are the instrument calibration factors which are entered via the keypad. They take into account a small quadratic non-linearity inherent in the ADC and in the conversion from electrostatic feedback voltage to force.

The uncorrected sample has drift correction and **GREF** applied and if selected, then also the tilt correction, to give a corrected sample

$$S = SU - DC + GREF + TIC = SU + C \quad (\text{B.5})$$

A running average of corrected samples (the function *S* in Figure B-2 on page B-3) gives the corrected reading

(B.6)

$$RU_{ij} = \frac{\sum_{j=1}^y \sum_{i=1}^x G\text{CAL}1 \left(\frac{SF_{ij}}{SC_j} \right) + G\text{CAL}2 \left(\frac{SF_{ij}}{SC_j} \right)^2 + C_{ij}}{(j-1)x + i - NR} = \frac{\sum_{j=1}^y \sum_{i=1}^x (S_{ij} + C_{ij})}{\text{DUR}}$$

Where **SC_j** is the value of the **jth** voltage calibration and **SF_{ij}** and **C_{ij}** are the **ith** gravity sample and correction after the **jth** voltage calibration.

**** Standard deviation—**

The standard deviation (**SD**) of the corrected samples is calculated every second and samples which are more *than four standard deviations from **RU_{ij}*** are rejected. This **AUTO REJECT** feature can be disabled via the keypad.

The **SD** is displayed every time except when the instrument calibrates itself, e.g. every 12 seconds, if **CAL AFTER** value 12 is selected, then the error (**ERR**) is displayed. It is recorded and output, as well. It is the measure of signal noisiness, which includes the instrumental and ambient seismic noise.

The current value of **RU_{ij}** is shown on the top line of the display during the reading period and the current sample number

$$\text{DUR} = (j - 1)x + i - \text{NR} \quad (\text{B.7})$$

where **NR** is the number of rejections. On the right hand side of the second line the display alternates between the latest value of the **ERR** during calibration sampling and the standard deviation of the mean. **ERR** is estimated under the assumption that the noise during gravity sampling is *normally* distributed (i.e. white) from the relationship:

$$\text{ERR} = \frac{\text{SD}}{\sqrt{\text{DUR}}} \quad (\text{B.8})$$

The formula given in Equation (B.8) is the one used in the CG-5. However, during periods of high seismicity (caused by microseismic noise), the standard deviation of the mean is better estimated by

$$\mathbf{ERR} = \frac{\mathbf{SD}}{\mathbf{DUR}} \quad (\mathbf{B.9})$$

if the **SEISMIC FILTER** is disabled, and

$$\mathbf{ERR} = \frac{\mathbf{SD}}{(\mathbf{DUR})^n} \quad (\mathbf{B.10})$$

where $n = 1$ to 2 , if the **SEISMIC FILTER** is selected.

**** Displayed reading—**

Sampling of the gravity signal stops when either **DUR** reaches the preset **READ TIME** or when the **MEASURE CLR** key is pressed. Up to three further corrections: the tilt correction (**TIC**), the temperature correction (**TEC**) and the earth tide correction (**ETC**) are then added to **RU** to give the reading **R** which is then displayed.

$$\mathbf{R} = \mathbf{RU} + \mathbf{TIC} + \mathbf{ETC} - \mathbf{TEC} \quad (\mathbf{B.11})$$

Seismic Filter

Scintrex firmware versions introduced a new way of gravity signal processing, called the **SEISMIC FILTER**. It is an optional filter. When disabled, the gravity signal processing is a continuous averaging of 1 second gravity signal samples, whereby all the samples are equally weighted. Sampling of the gravity signal is interleaved with 1 second calibrations. The repetition rate of calibrations is controlled by **CALIBRATE AFTER** parameter (usually 12).

This signal processing works fine when the seismicity is low - **SD** (standard deviation of 1 second gravity signal samples) is less than about 0.05 mGal. It offers optimal filtering of the noise from the analogue to digital converter, which is prevalent noise at these low levels of ambient seismic noise. In the Scintrex gravity lab, the **SD** seldom exceeds 0.1 mGal level. Most of the time this high seismicity is caused by wave action (microseisms) in the Atlantic

Ocean (nearest distance from Toronto is about 800 km). The frequency of microseismic signals recorded in Toronto is in the range of 1/4 to 1/7 Hz. Highest **SDs** in the Scintrex lab were recorded during earthquakes (about 1.5 mGal). However, we were notified by our clients of much higher microseismic noise levels: **SD** in the range of 1.5 mGal during a typhoon in Tokyo, 0.3 mGal in Northern Italy, up to 0.5 mGal during cyclone in Australia.

On a past survey a CG-3M meter (equivalent to the CG-5 sensor) recorded **SD** in the range of 2.5 mGal on the 1.5 in thick ice in the shallow Prudhoe Bay, North Slope Alaska. To reduce the measurement noise in situations like these we devised a different way of gravity signal processing which we named the **SEISMIC FILTER**.

In short, the difference between processing of 1 second gravity signal samples of the seismic filter and the standard filter is as follows:

1. The sampling of the gravity signal is not interleaved with sampling of the calibration signal (voltage reference). In stead, a group of calibration samples is taken before and after the gravity signal measurement,
2. Gravity samples are not equally weighted as in the standard filter- a special weighting function is used to suppress the edge effects.
3. The rejection threshold has been increased from 4 x **SD** to 6 x **SD**. The lead time of 5 seconds, before the rejection is enabled, has remained unmodified. The value of a rejected sample is replaced by the value of the previous sample. The reason for increasing the rejection threshold is that, during microseisms, the seismic noise level varies greatly. If the measurement starts during occasional low noise intervals the rejection threshold is set too low, and subsequent higher level seismic noise is rejected, resulting in numerous rejections. This defeats the benefits of the **SEISMIC FILTER**.



Note:

The rejection is designed to eliminate noise spikes and not the microseismic noise. In addition, it is worth noting that the seismic filter very effectively reduces measurement errors due to noise spikes

which occur during the first 5 seconds after the start of a measurement, as weighting factors of early samples are relatively small.

During the periods of low seismicity ($SD < 0.05$ mGal) the performance of this filter is slightly inferior to the standard, interleaved measure/calibrate processing. During time intervals when the seismic noise containing waves with periods of 4-30 seconds increase, causing the SD to go above approximately 0.1 mGal, selecting the seismic filter could decrease the measurement errors considerably.

The factor by which the measurement errors are reduced depends on seismic noise amplitude level, the seismic waves period and the gravity measurement duration. Reduction of measurement errors was observed, during earthquakes, hurricanes and cyclones, by comparing cyclic gravity measurements of 60 sec. in duration recorded by two meters, running next to each other on the solid ground. One meter was using the seismic filter while the other was using a standard filter. Two such records are presented:

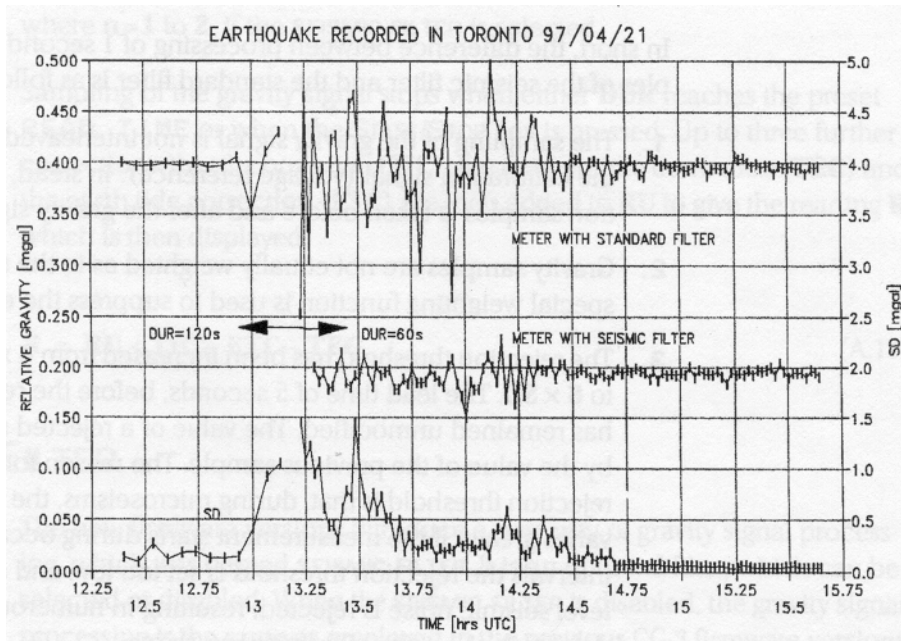

Theory

Figure B-2 - Plot of gravity measurements during an earthquake

Figure B-2 shows plots of gravity measurements in the Scintrex Toronto lab during an earthquake (sequence of earthquakes near the Santa Cruz Islands, South Pacific, surface wave magnitude of 7.9, body wave magnitude up to 6.1). At about 13:15 two meters were set to measure gravity using $DUR = 60$ s and $T_{cycle} = 75$ s settings. Just before, the analogue gravity signal of one meter was observed on a digital oscilloscope. The signal was nearly perfect sine wave with the amplitude of 2.2 mGal peak and the frequency of 1/16 Hz. During the duration of the earthquake, both the amplitude and the frequency were changing.

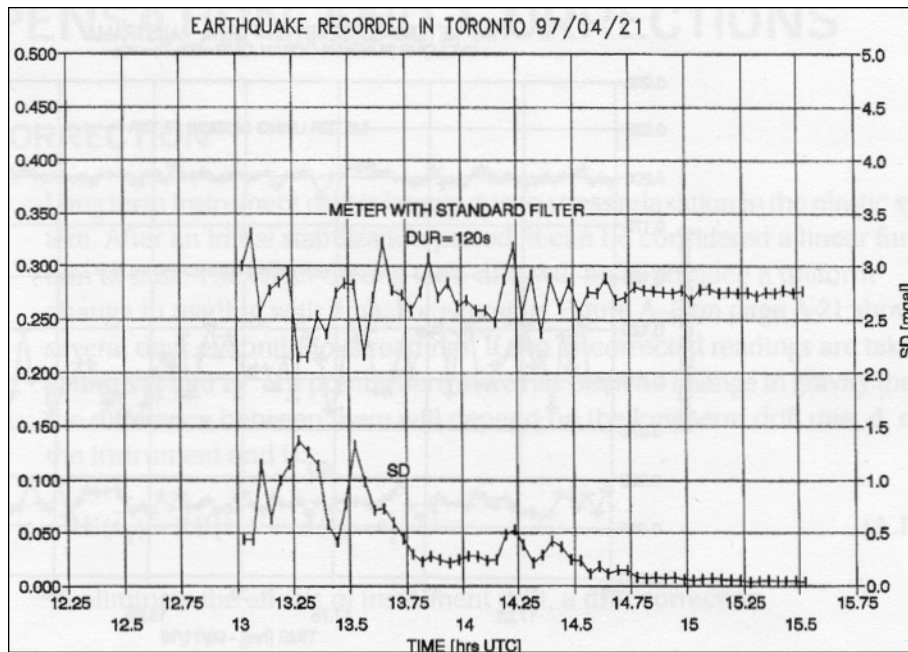

Figure B-3 - Gravity data during an earthquake. Measured using standard filters and longer measuring time. Compare with Figure B-2.

The top trace, shows the gravity measurements recorded with the meter using the standard filter (SEISMIC FILTER < DISABLED). The noise envelope is over 0.2 mGal. At the same time, see middle trace, the gravity

measurements were recorded with the meter using the seismic filter (SEISMIC FILTER < ENABLED) . The noise envelope is about 0.7 mGal.

The bottom trace shows the **SD** of 1 second samples of the meter with the standard filter. The **SD** of the other meter is not much different, as both meters see the same disturbing seismic event. Figure B-3 depicts the measurements taken with a meter using the standard filter, but measuring two times longer - DUR = 120 s and Tcycle = 150 s. In spite of that the noise envelope (over 0. 1 mGal) is larger than the one of the meter using seismic filter, and measuring two times faster.

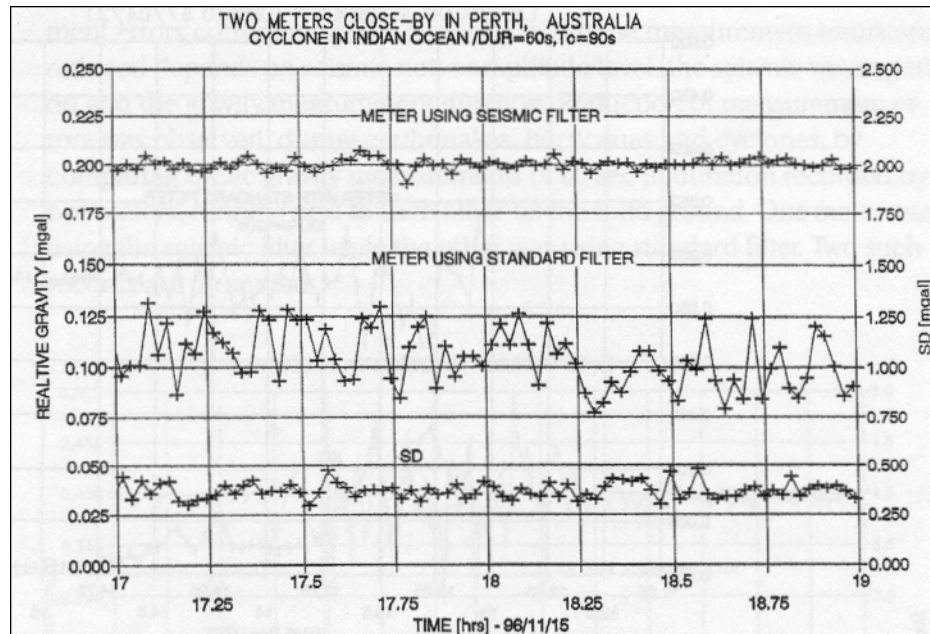

Figure B-4 - Comparative data showing the benefits of the seismic filter.

This example shows the superiority of new signal processing. Still, you will not be able to conduct microgravity survey during such large seismic disturbances. But there are smaller tremors and ocean storm induced microseismic noise, during which you could obtain good gravity measurements, if you select the seismic filter, see Figure B-4. This data was recorded in Perth, Australia during a cyclone in the Indian Ocean.

The **SD** was in the range of 0.4 mGal for at least one day (our record, out of which only one tenth is shown, is only 21 hours long due to the memory capacity restrictions while cycling at relatively fast rate). During the period of two hours depicted on Figure B-4, the standard deviation of gravity measurements (the measurement error) of the meter using the seismic filter was 0.003 mGal (just a bit higher than when the seismic noise is low), while the standard deviation of gravity measurements of the meter using the standard filter was 0.0 13 mGal.

Compensation and Corrections

The following are the types of corrections considered in this section:

- Drift correction
- Tilt correction
- Temperature compensation
- Earth tide correction
- Gravity offset

Some corrections, such as temperature compensation, are performed automatically in the system. However, the theory is provided here for completeness.

Drift Correction

Long term instrument drift is largely due to stress relaxation in the elastic system. After an initial stabilization period, it can be considered a linear function of time. The effect of long term drift will be to produce a uniform change in reading with time. For example, the figure on page B-21 shows several days of continuous readings. If two uncorrected readings are taken at times t_j and t_2^1 at a point where there has been no change in gravity, then the difference between them will depend on the long term drift rate, d , of the instrument and is:

$$RU(\bar{t}_2) - RU(\bar{t}_1) = d(\bar{t}_2 - \bar{t}_1) \quad \text{(B.12)}$$

1. \bar{t}_n is the midpoint between the start and finish of a reading.

To eliminate the effects of instrument drift, a drift correction

$$\mathbf{DC} (t) = (t - t_s)\mathbf{DRIFT} \quad (\mathbf{B.13})$$

is subtracted from each uncorrected sample SU.

DRIFT is the drift constant with units of mGal/24hrs, t_s is the drift correction start time and t is the time at which the samples are taken. Both **DRIFT** and t_s are entered via the keypad.

With the drift correction applied, Equation (B. 12) becomes:

$$\begin{aligned} \mathbf{R} (\bar{t}_2) - \mathbf{R} (\bar{t}_1) &= \mathbf{RU} (\bar{t}_2) - \mathbf{DC} (\bar{t}_2) - \mathbf{RU} (\bar{t}_2) + \mathbf{DC} (\bar{t}_1) \\ &= (d (t_2 - t_1) - \mathbf{DRIFT} (t_2 - t_1)) \end{aligned} \quad (\mathbf{B.14})$$

If the drift correction is properly adjusted:

$$\begin{aligned} \mathbf{DRIFT} &= d \\ \mathbf{R} (\bar{t}_2) - \mathbf{R} (\bar{t}_1) &= 0 \end{aligned} \quad (\mathbf{B.15})$$

The procedure for adjusting the drift correction is given in the Maintenance section starting on page 5-15.

Tilt Correction (TIC)

The uncompensated gravity reading changes in response to tilt according to the following expression:

$$\mathbf{RU} (\alpha_x, \alpha_y) = \mathbf{RU} (0, 0) - g (1 - \cos \alpha_x \cos \alpha_y) \quad (\mathbf{B.16})$$

2. calculation precision limits the maximum of (t-ts) to 4 months (128 days)

g is the value of gravity at the reading site and α_x and α_y are the tilts of the gravity sensor about two horizontal axes (x and y) with α_x and $\alpha_y = 0$ being defined as the orientation in which the uncompensated gravity meter is maximized.

The tilt correction operates over a range of +/- 200 arcsec and is:

$$\mathbf{TIC} = \mathbf{g}_t (1 - \cos \alpha_x \cos \alpha_y) \quad (\mathbf{B.17})$$

where \mathbf{g}_t is an average sea level gravity of 980.6 Gal and X and Y are the indicated gravity meter tilts.

Assuming $\mathbf{g}_t = \mathbf{g}$ (this assumption leads to an error of 0.002 mGal in the worst case), the corrected reading value will be:

$$\mathbf{RU}(\alpha_x, \alpha_y) = \mathbf{RU}(0, 0) - \mathbf{g}_t (\cos \alpha_x \cos \alpha_y - \cos x \cos y) \quad (\mathbf{B.18})$$

If

$$x = \alpha_x \quad (\mathbf{B.19})$$

$$y = \alpha_y$$

then

$$\mathbf{RU}(\alpha_x, \alpha_y) = \mathbf{RU}(0, 0) = 0 \quad (\mathbf{B.20})$$

and errors due to instrument tilt are eliminated. The method used to adjust X and Y so that equation (B.19) is satisfied is given in the Maintenance section starting on page 5-17. There are two selectable modes of operating the tilt correction:

1. (CONT. TILT CORR - SELECTED), a correction is applied to each one second sample.
2. (CONT. TILT CORR - DISABLED), a correction is only applied at the end of the reading based on the X and Y values of the last one second

sample of the reading.

The reason for two modes of operation is that the tilt sensors have a relatively fast response (typically a few seconds) up to within approximately 5 arcsec of the final value and then it takes up to a minute to come to within one arcsec of the final value.

If the Autograv is on a solid base and it does not move during the reading, then the OFF mode will give the most accurate result as the tilt sensors will have more time to settle before a compensation is applied.

If the instrument is on a soft base and moves during a reading, then it is preferable to select the continuous correction mode.

It should be noted that over a period of several hours, some tilt changes may arise from movement of the elastomer in the shock isolators (used to protect the sensor from severe shocks). This not relevant for the Reading mode. In the Base Station mode, however, these changes are corrected by the tilt correction function, regardless of whether or not the tilt correction function is enabled or disabled.

Temperature Compensation (TEC)

The fused quartz mainspring is the most temperature sensitive component in the gravity meter with a coefficient of approximately - 130 mGal/°K (spring becomes stronger as the temperature increases). This spring is protected from ambient temperature changes by a two stage thermostat which maintains the spring temperature T_s constant to within 0.5mK under normal operating conditions.

The changes in T_s are measured using a temperature sensor in good thermal contact with the mainspring. The output of the temperature bridge is converted to a digital signal, **TEMP** shown in the figure on page B-3 and this is converted to the temperature compensation signal.

$$\text{TEC} = \text{TEMPCO} \times \text{TEMP} \quad (\text{B.21})$$

TEMPCO is the instrument temperature coefficient in mGal/mK. It is measured during the production of each instrument and is entered through the keypad. A new value of TEC is computed and applied after the last sample has been taken.

The spring temperature **TEMP** in units of mK can be displayed on the liquid crystal display. The last **TEMP** value for each reading is also stored in memory together with other measurement variables. The range of **TEMP** is ± 500.0 mK, and it is adjusted with a zero offset to within ± 10.0 mK for normal operation.

The chamber temperature is measured by a set of two thermistors, which themselves exhibit a long-term drift due to their aging. However, the effect of this drift is *indistinguishable* from the gravity sensor drift, and is corrected by the linear drift correction.



Note:

With the electronics used in the CG-5, there is no requirement for the user to adjust the temperature compensation as with previous meters. The system has enough dynamic range to accommodate any temperature variations experienced with the system.

Earth Tide Correction (ETC)

The ETC is generated in the software via the Longman¹ formula (gravimetric factor = 1.16) by entering in the latitude, longitude and difference between the gravimeter clock time and GMT from the keypad. It is applied after the last sample has been taken and it may also be disabled via the keypad. The time used in the tidal calculation is the midpoint between the start and the end of a reading.

It is critical that the UTCDIFF (see page 2-7) is properly input into the CG-5. If the sign is entered incorrectly or the value is wrong because the local daylight savings time shifts (summer time) are not properly accounted for, then the resulting corrections will be poor.

Residuals

The ETC will compensate for the gravity effects of the Sun and Moon to within (usually) ± 3 ugals. Tidal accelerations cause elastic deformations to the Earth's body (*earth body tides*). The average effect of this deformation is taken into account by the gravimetric factor 1.16 in the Longman formula (16% increase over the amplitude of gravimetric tides of the rigid Earth).

1. Longman, I.M., Journal of Geophysical Research, Volume 64, No. 12, Formulas for Computing the Tidal Accelerations Due to the Moon and the Sun, December 1959.

Slight variances of gravimetric factor exist. The gravimetric factor is *latitude* dependent and different tidal waves have slightly different factors. This may result in minor residuals of a semi-diurnal and diurnal nature having amplitudes of about ± 3 uGals.

In addition, the ocean tides, besides their direct gravitation, cause additional deformation by their loading. These deformations lead to additional changes of the gravity values observed on the surface of the Earth. The residuals from both effects could be effectively removed from field measurements by using another gravity meter as a base-station (Figure B-5).

Gravity Offset (GREF)

This value is in mGal and entered from the keypad. It is added to each reading sample.

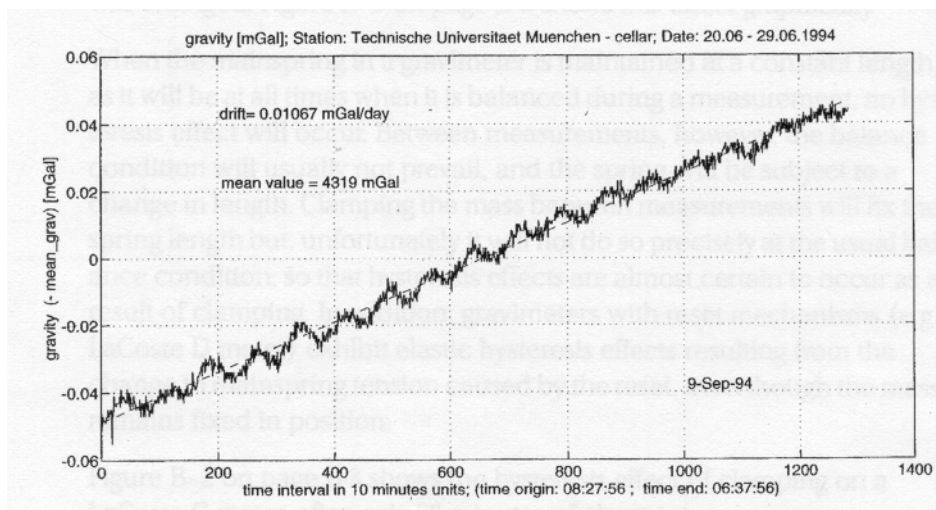
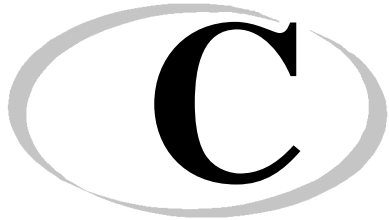

Figure B-5 - Continuous measurement over ten days showing the linear nature of drift together with other phenomena, such as ocean loading tide.

Theory





Elastic Hysteresis Effects

All springs, however elastic, exhibit what is known as elastic hysteresis or stress relaxation effects. This occurs, for example, when the spring length is changed for a time (by a change in tension on the spring) and then returned to its original tension. When this happens, the spring does not instantaneously return to its original length, but has a small memory effect, which slowly relaxes with time and eventually disappears. The relaxation time may be of the same order as the length of time over which its tension was changed. The figure on page C-2 shows this effect graphically.

When the mainspring in a gravimeter is maintained at a constant length, as it will be at all times when it is balanced during a measurement, no hysteresis effect will occur. Between measurements, however, the balance condition will usually not prevail, and the spring will be subject to a change in length.

Clamping the mass between measurements will fix the spring length but, unfortunately it will not do so precisely at the usual balance condition, so that hysteresis effects are almost certain to occur as a result of clamping.

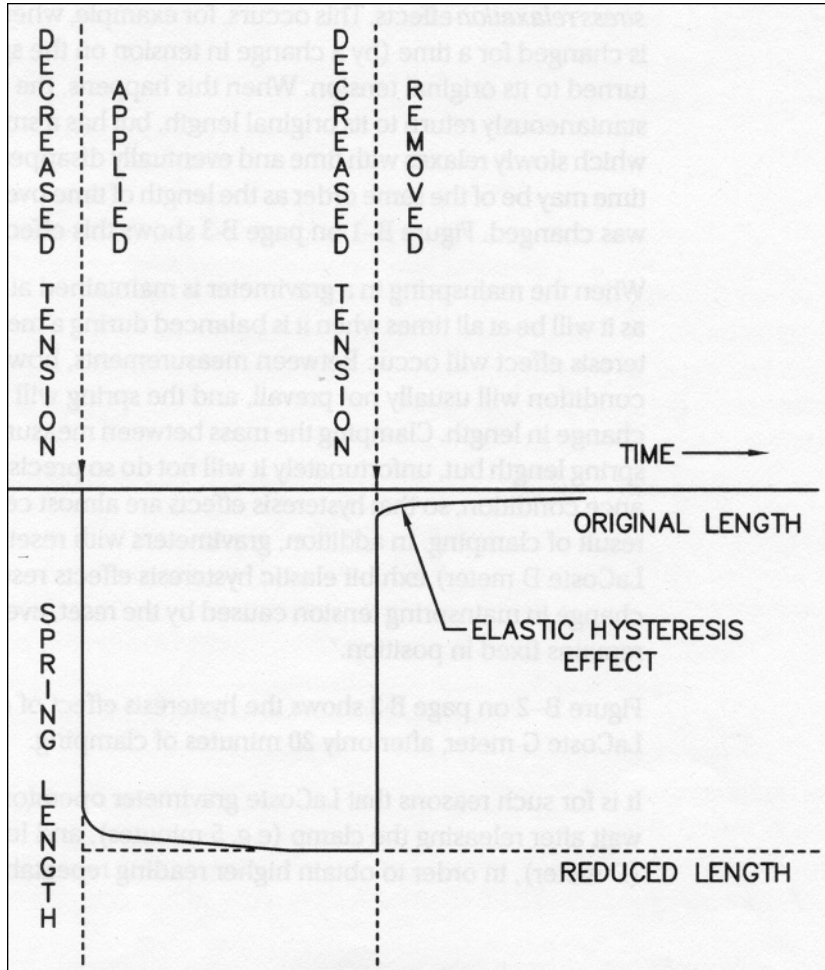

Figure C-1 - Elastic Hysteresis Effect

Hysteresis effects are possible the Autograv is left stationary off level, i.e. out of its measuring range, for significant lengths of time.

For this reason, it is recommended that whenever the Autograv is not being transported between stations, it should be leveled on its tripod so that the mass and spring are in their normal configuration. When in transit, hysteresis

effects do not build up to any extent because the bipolar, high frequency changes in tension on the spring effectively cancel out any tendency for such effects to build up.



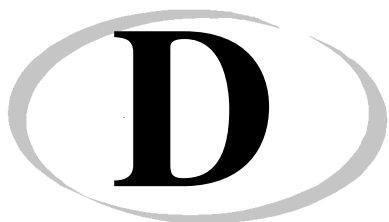

Scintrex Utilities Program

The SCTUTIL Scintrex utilities program is an application software that allows the user to download data from the CG-5 as well as upload the most current version of the CG-5 operating software supplied to you by Scintrex.

The SCTUTIL program is located on the CD-ROM disk provided with every CG-5.

You will find this CD-ROM is one of the compartments of your CG-5 transit case.

Installing SCTUTIL

Before you can use the SCTUTIL utilities program, you must first install it on your PC.

Insert the SCTUTIL CD-ROM in the proper drive on your PC.

The installation program is self-executable, therefore you should see the following screen appear.

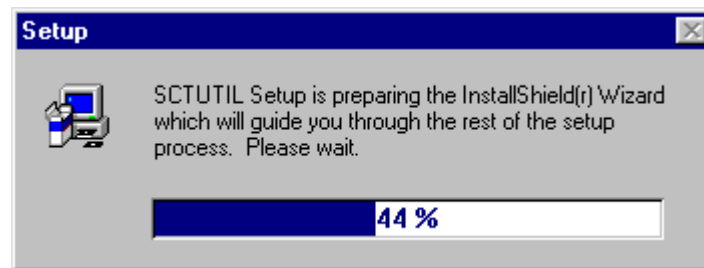

If it does not appear, *go* to your CD-ROM drive and *run* the Setup.exe program.

After the Install Shield Wizard is prepared, the following screen will then appear.

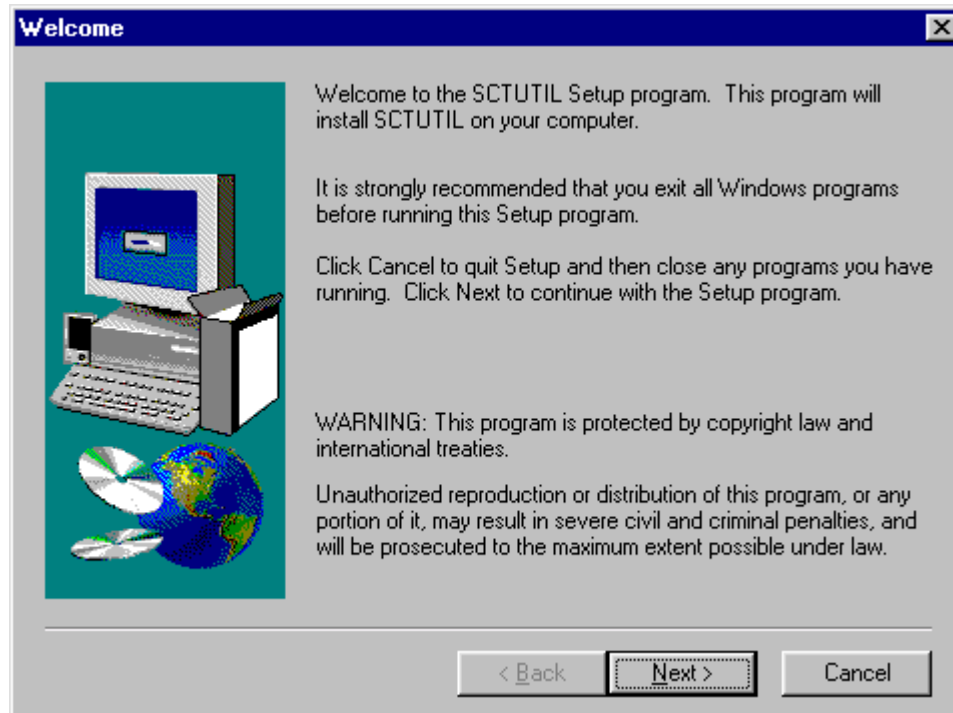

Click on Next>.

The following screen will then appear.

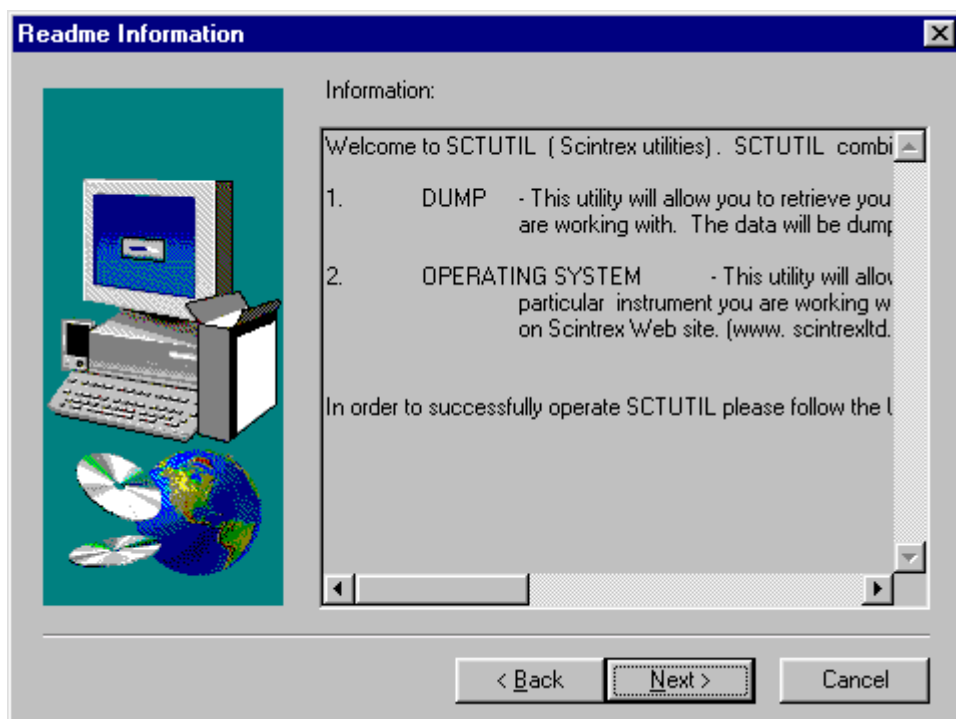

Click on Next>.

The following screen will then appear.

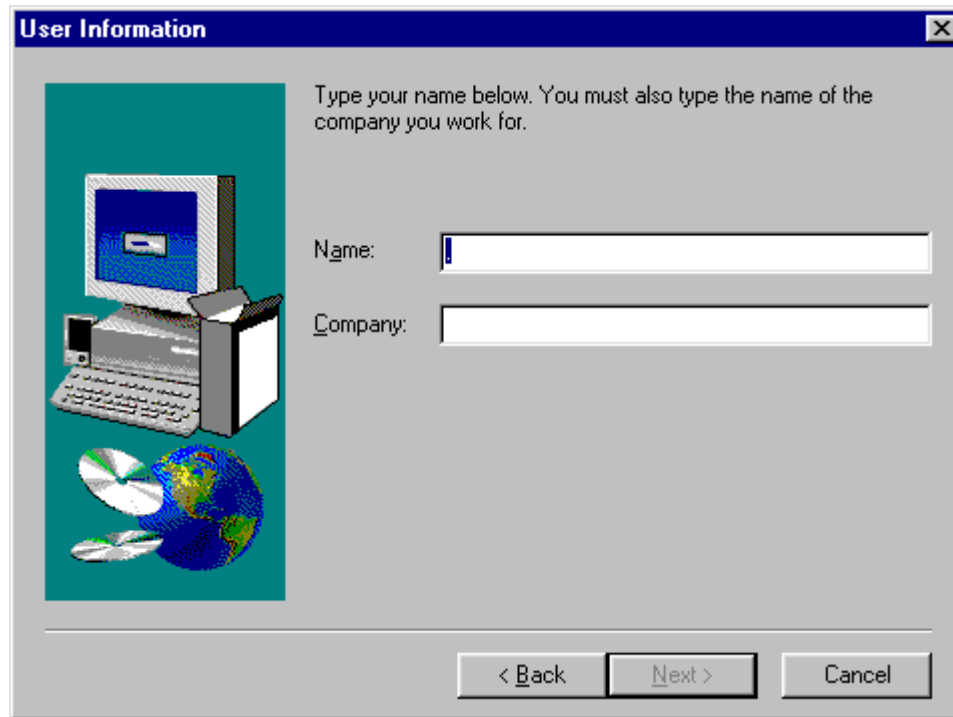

User Information

Type your name below. You must also type the name of the company you work for.

Name:

Company:

< Back Next > Cancel

If you wish, **type** your name and company.
Click on Next>.

The following screen will then appear.

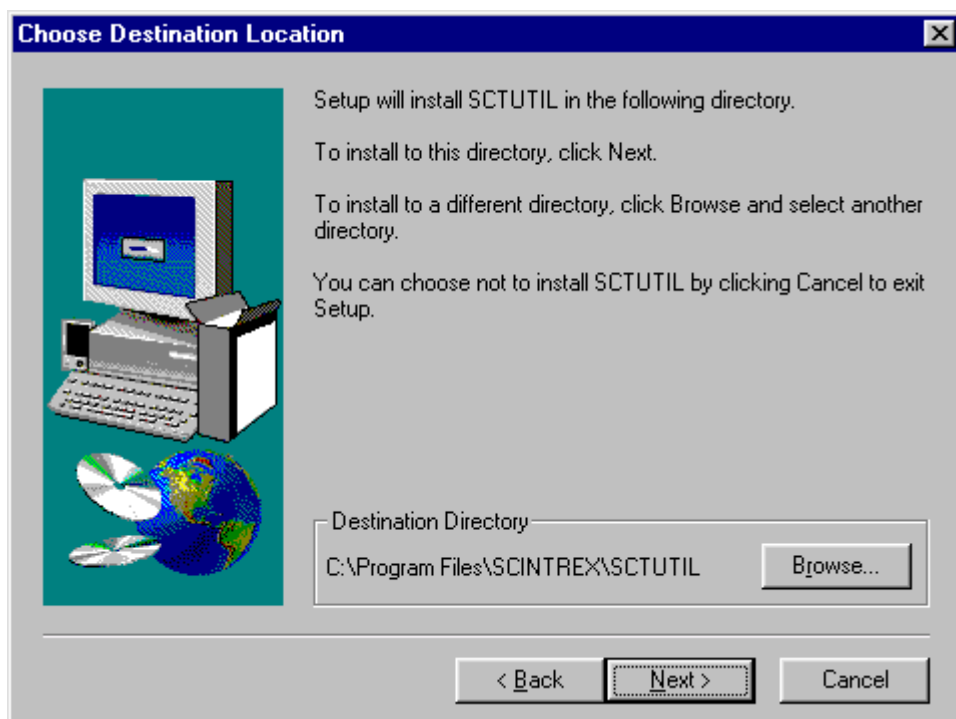

If you do not want the program to be installed in the default directory, **click** on Browse to choose another directory and then **click** on Next>, otherwise just **click** on Next>.

The following screen will then appear.

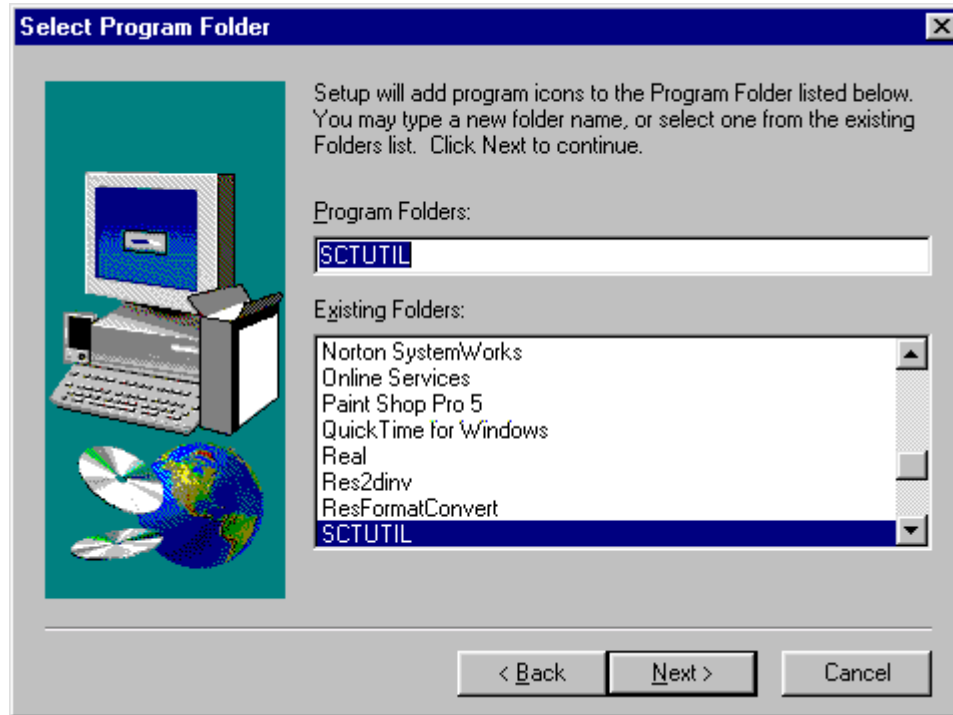

Click on Next>.

The following screen will then appear.

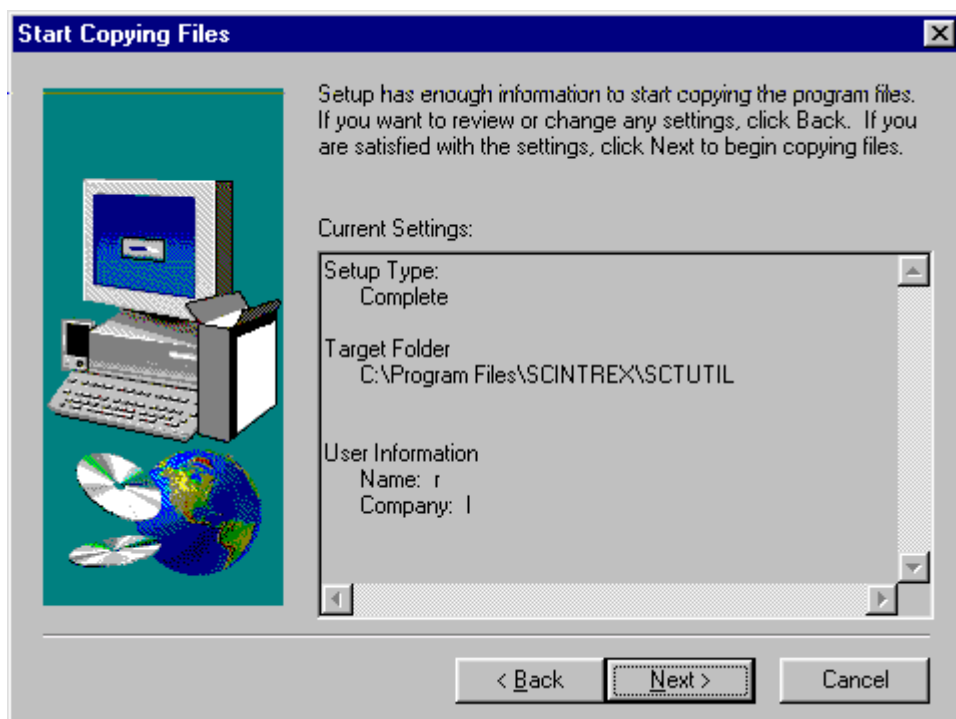

Click on Next>.

The installation program will then load the appropriate files onto your PC.

When the installation is complete, you can run the program by clicking on the SCTUTIL icon. 

Installing your USB driver

The USB driver is located on your SCTUTIL CD-ROM. Before transferring data in USB mode from your CG-5 to your PC, you must first install this driver on your PC.

Close all applications on your PC.

Insert the SCTUTIL CD-ROM in the proper drive on your PC.

Installing your CG-5 USB Driver in Windows 98

1. Turn on the CG-5 and the computer. Connect one end of the USB cable to the USB port on the CG-5. Connect the other end of the USB cable to the USB port on the computer. If the connection is successful and the CG-5 USB device has never been installed on your PC, Figure 1 will be shown immediately. Then click the “Next” button to continue with the installation.



2. Select “Search for the best driver for your device (Recommended)”. Then click the “Next” button to continue the installation.



3. Insert the included SCTUTIL CD into the CD-ROM drive, then select “Specify a location”, click on the “Browse” button, select the appropriate CD-ROM drive letter and the USBDRV folder (D:\USBDRV) then click the “Next” button.



4. The Windows operating system has found the best driver for the device. Select “the updated driver (Recommended)”, and then press the “Next” button to continue.



5. Press the “Next” button to continue the installation procedure. The location of the driver is shown (Example: :\\USBDRV\\SCINTREX.INF).



6. The Windows Operation System has installed the software for the device. Then press the “FINISH” button to complete the installation.



7. Then the hardware information of USB CG% driver will be shown in the PC's Device Manager. (From the desktop right-mouse click on the “My Computer” icon, select “Properties” and click on the “Device Manager” tab).

Re-boot your PC to acknowledge the changes.

Your USB driver is now installed.

Installing your CG-5 USB driver in Windows 2000

1. Turn on the CG-5 and the computer. Connect one end of the USB cable to the USB port on the CG-5. Connect the other end of the USB cable to the USB port on the computer. If the connection is successful and the CG-5 USB device has never been installed on your PC to following will be shown immediately. Then click the “Next” button to continue with the installation.



2. Select “Search for a suitable driver for my device”

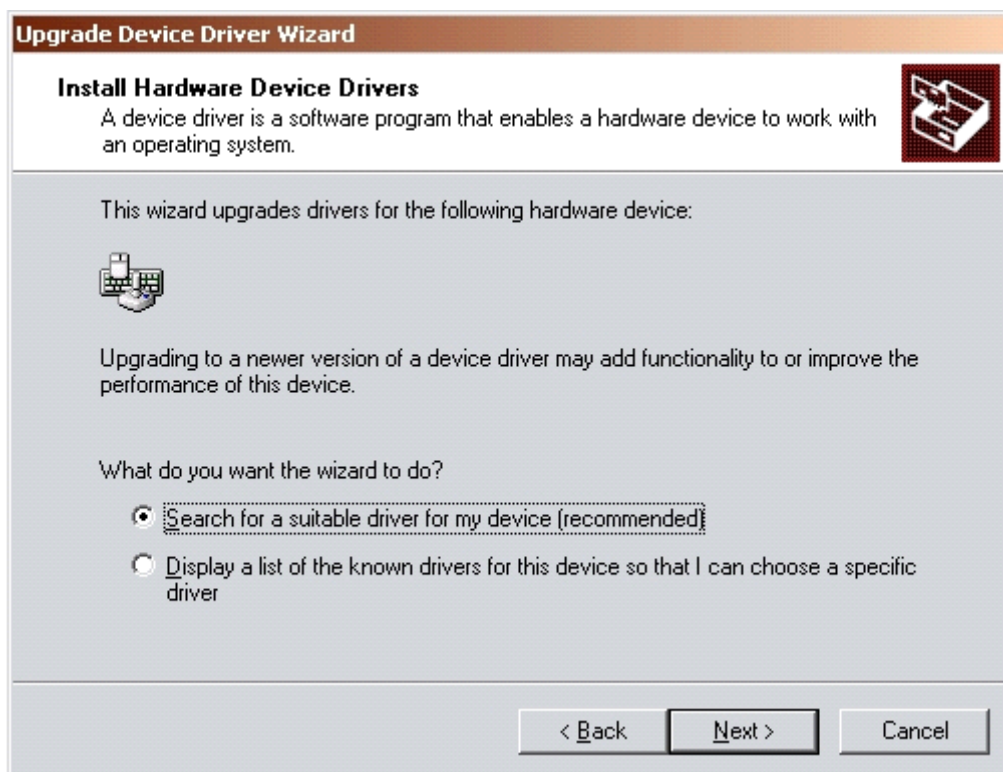

3. Select “Specify a location” and click “Next”.

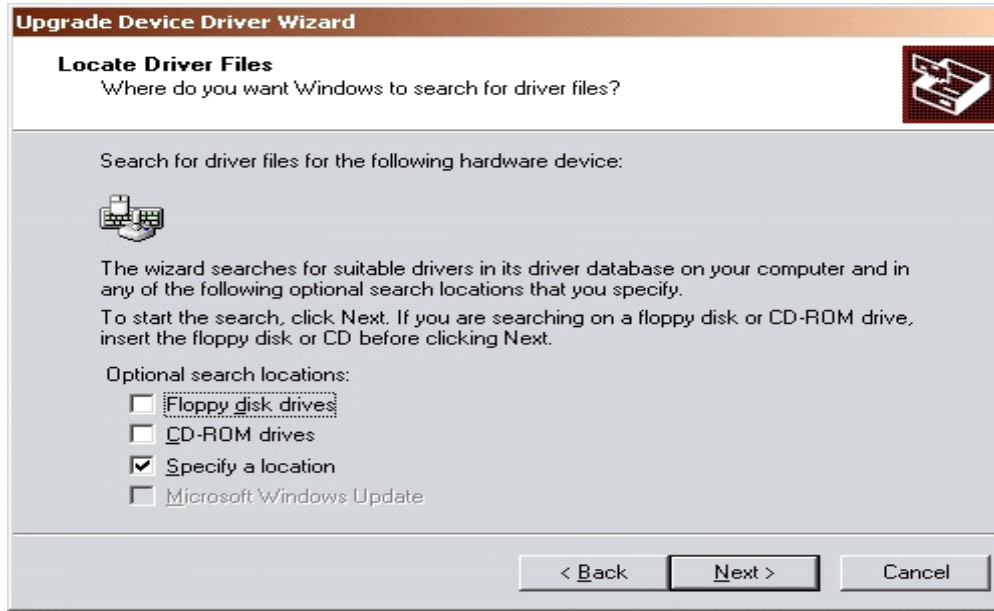

4. Click “Browse” and select your CD-ROM drive.

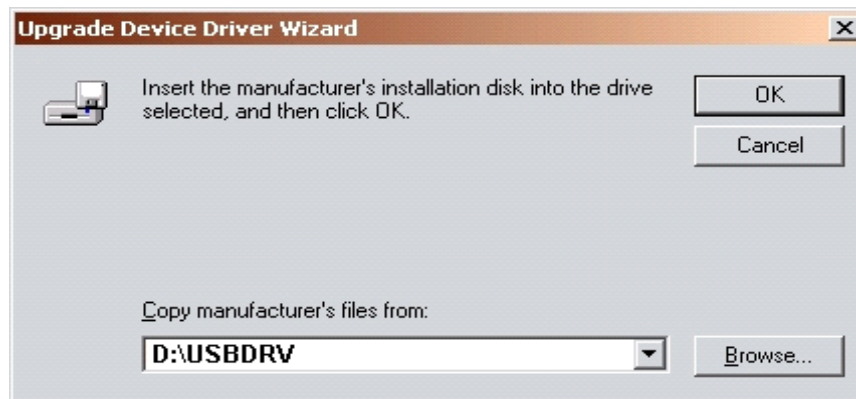

5. Then select “Scintrex.INF” from the CD-ROM in the USBDRV Driver folder.

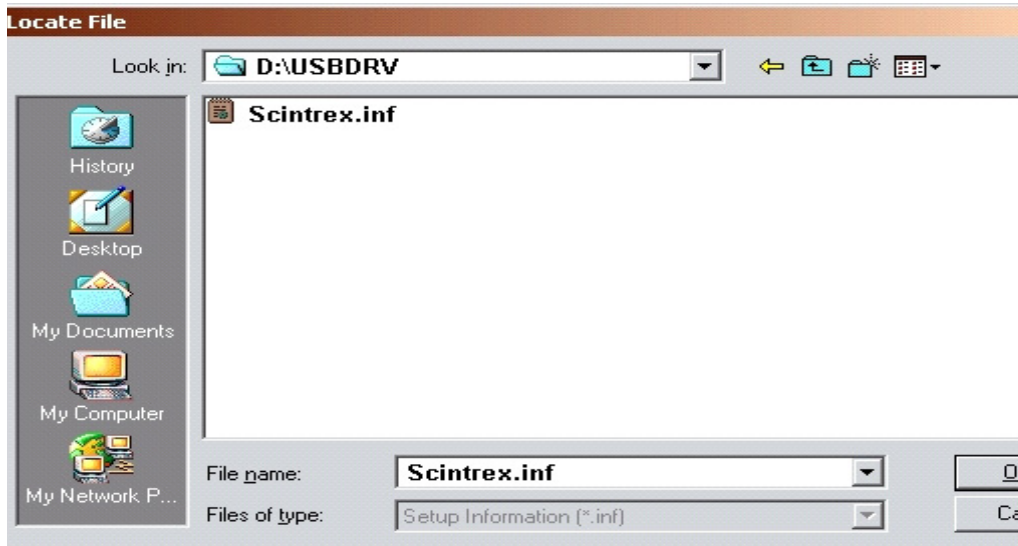

6. Click “Next”.



7. Click “Finish” to complete the installation.
Re-boot your PC to acknowledge the changes.
Your USB driver is now installed

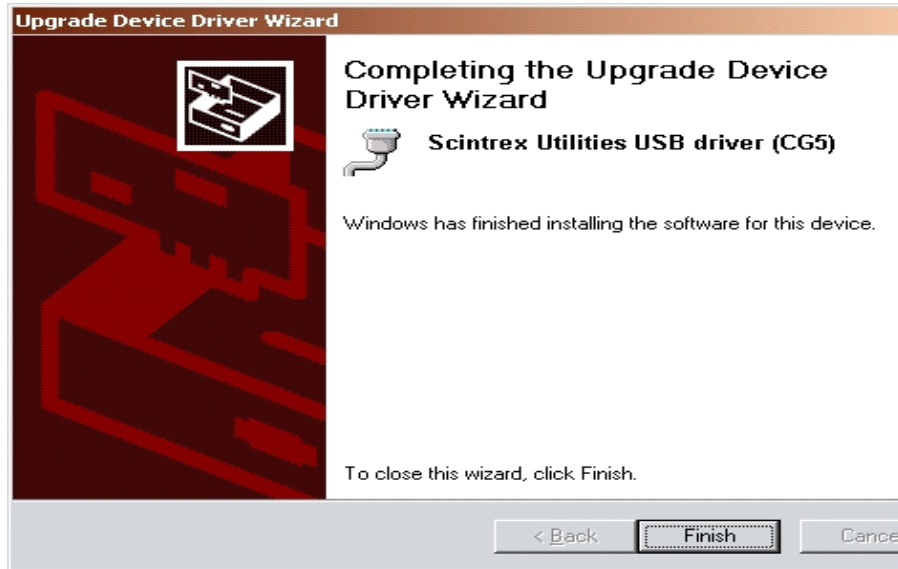

Installing your CG-5 USB Driver in Windows XP

1. Turn on the CG-5 and the computer. Connect one end of the USB cable to the USB port on the CG-5. Connect the other end of the USB cable to the USB port on the computer. If the connection is successful and the CG-5 USB device has never been installed on your PC the following will be shown immediately. Then click the “Next” button to continue with the installation.



Welcome to the Hardware Update Wizard

This wizard helps you install software



If your hardware came with an installation CD or floppy disk, insert it now.

What do you want the wizard to do?

- Install the software automatically (Recommended)
- Install from a list or specific location (Advanced)

Click Next to continue.

2. Select “Don’t search. I will choose the driver to install”.

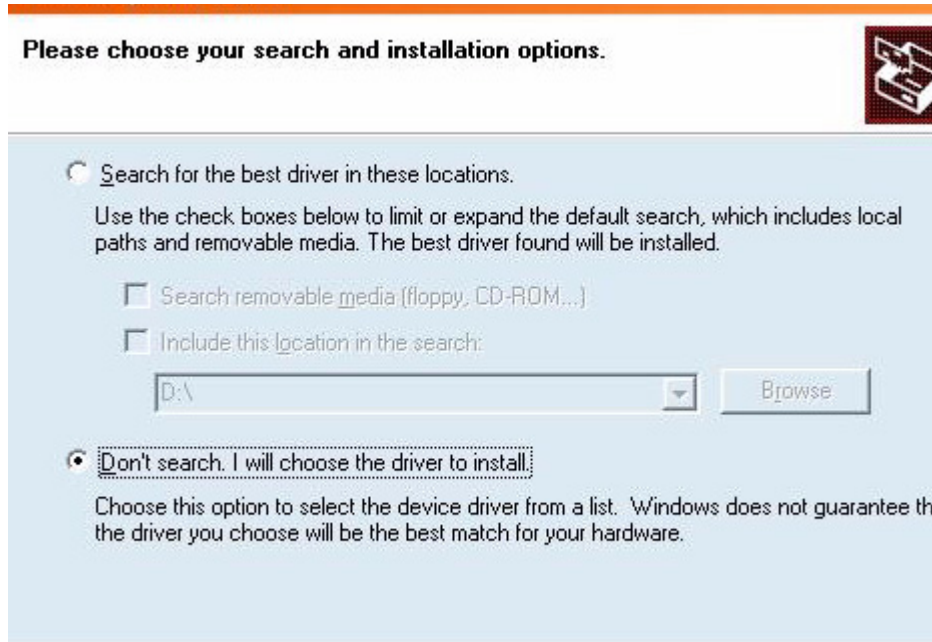

3. Click “Browse” and select your CD-ROM drive.

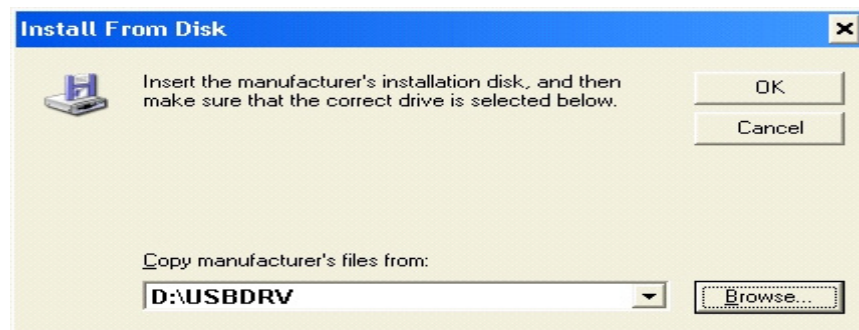

4. Then select 'SCINTREX.INF' from the CD in the USB DRV folder.

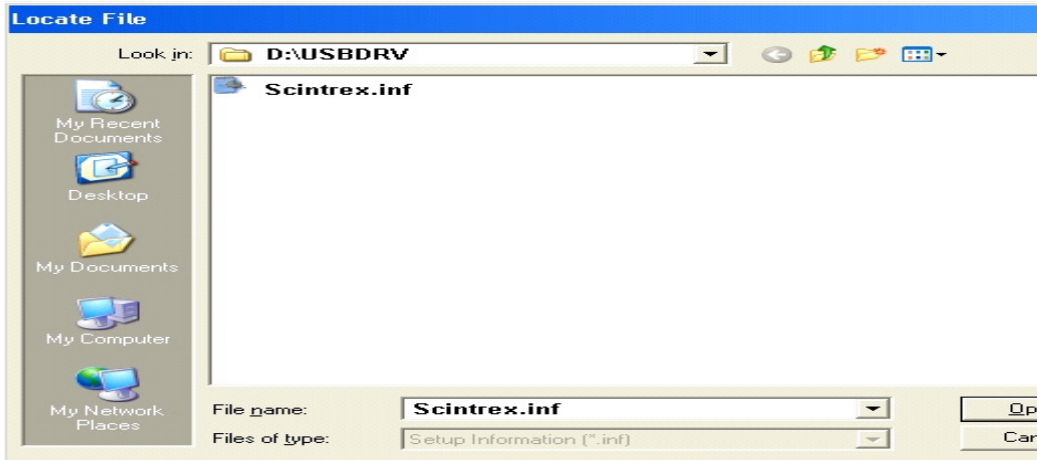

5. Click "Open".

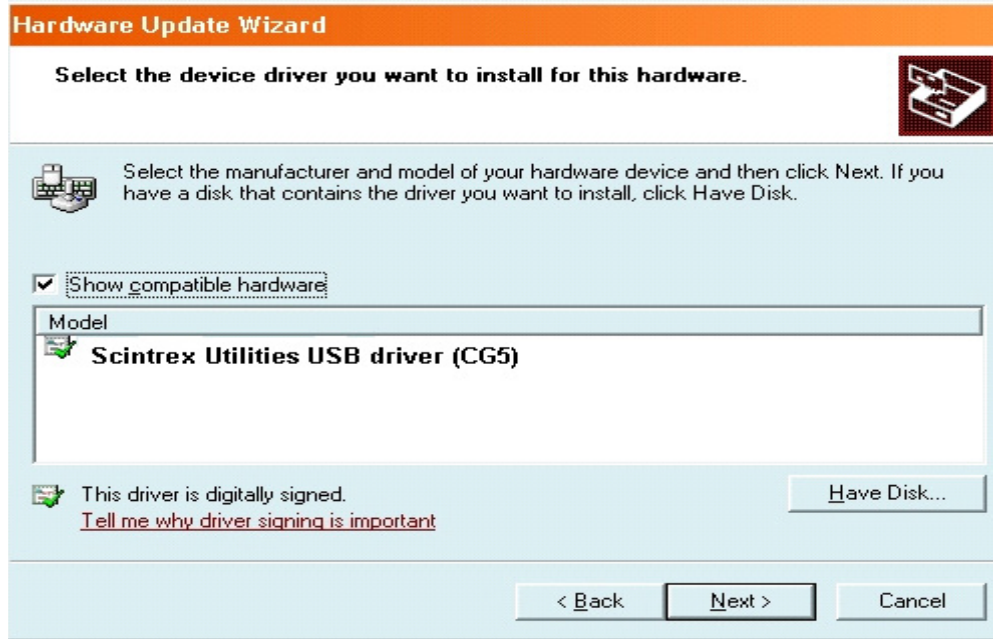

6. Click “Next”.

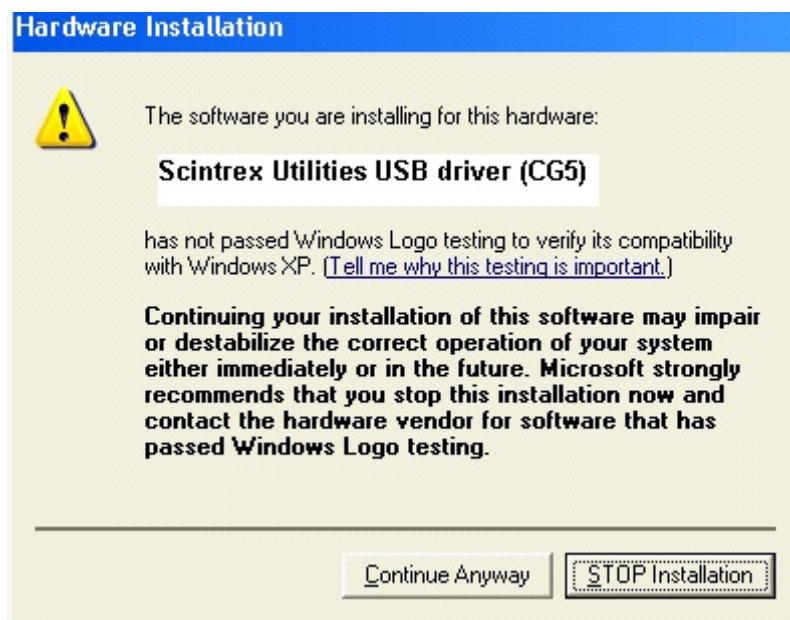

7. Click “Continue Anyway”. Wait for Windows XP to set a restore point and install the device driver, then click “Next” to continue.

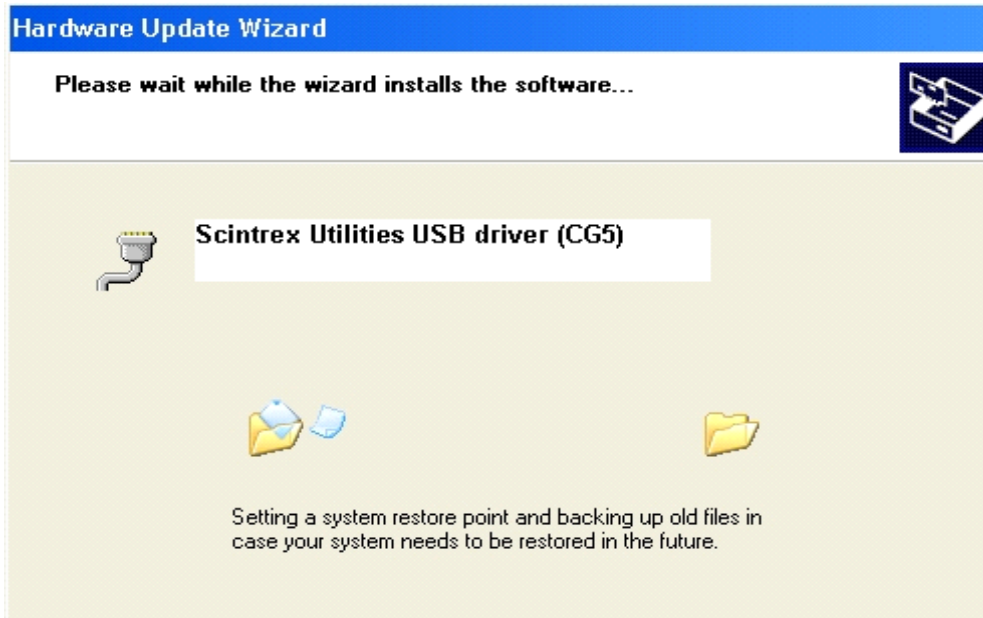

8. Click “Finish” to complete the driver installation and close the update wizard.



Completing the Hardware Update Wizard

The wizard has finished installing the software for:



Scintrex Utilities USB driver (CG5)

The hardware you installed will not work until you restart your computer.

Click Finish to close the wizard.

Re-boot your PC to acknowledge the changes.
Your USB driver is now installed.

E

CG-5 Menu Maps

This chapter provides an overview of all menus in the CG-5 system and can be used as a tool in learning and navigating the system.

Menus are organized in three components:

- Setup. This mapping comprises all menus related to the SETUP/4/JKL key. This includes Survey, Autogray, Options, Clock, Dump and Service menus. In some cases, two menus are shown in the same menu map to conserve space.
- Measurement. There are three measurement processes in the system as shown below. The normal measurement process is simply to level and take a reading. However, the measurement process can change depending on whether you enable the terrain correction or tilt sensitivity correction.

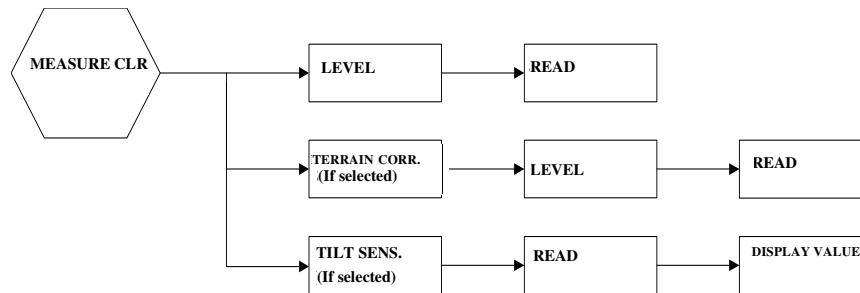

-
- Other menus. This mapping comprises other system menus activated via the RECALL/5/MNO, DISPLAY/6/PQR, INFO/7/STU and NOTE/8/VWX keys.

Setup Menu Maps

Survey Menu

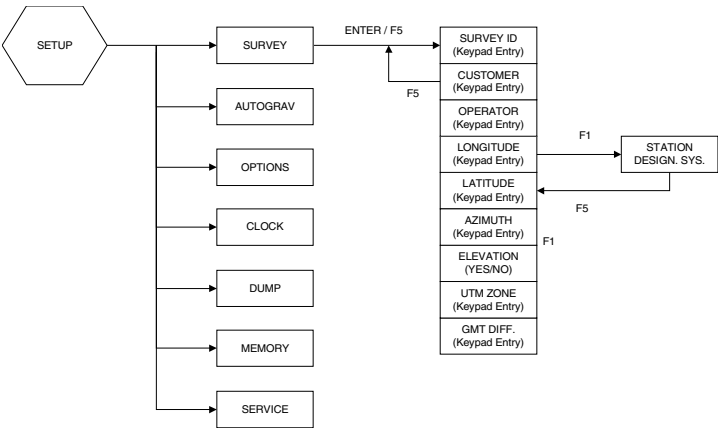

Menu Maps

Autograv Menu

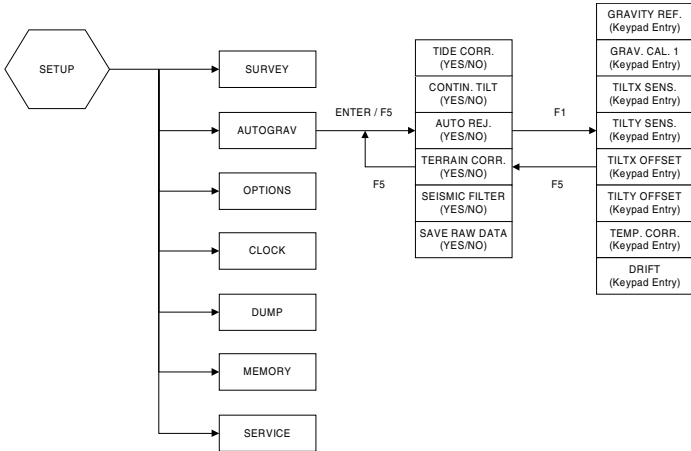

Options Menu

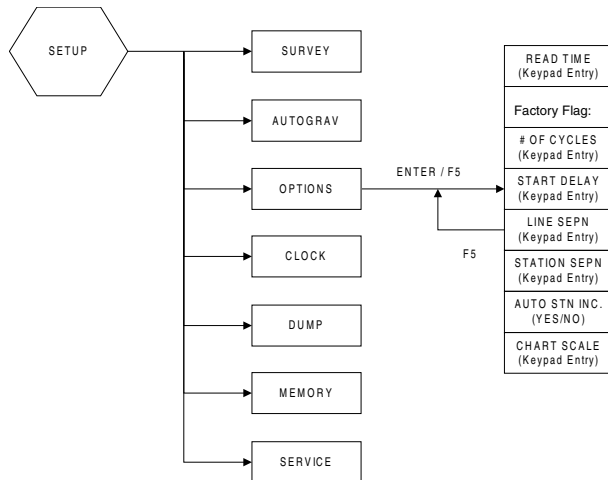

Clock and Memory Menus

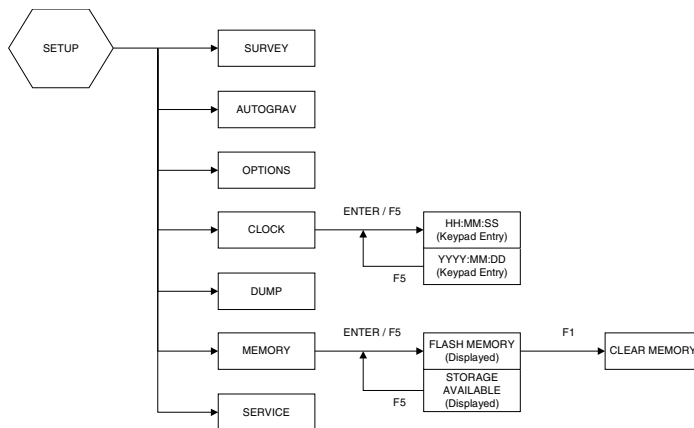

Dump and Service Menus

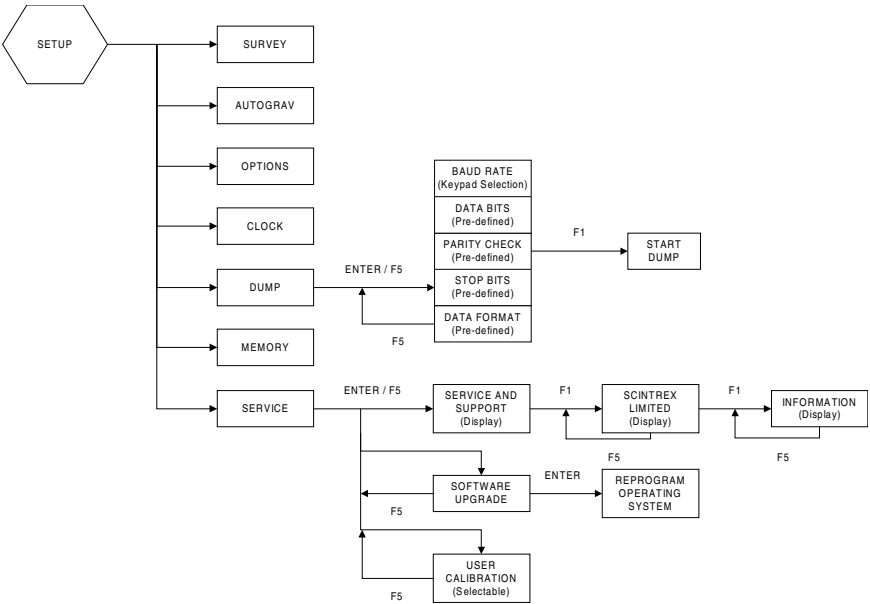

Menu Maps

Measurement Menu Maps

Main Measurement Process Flow

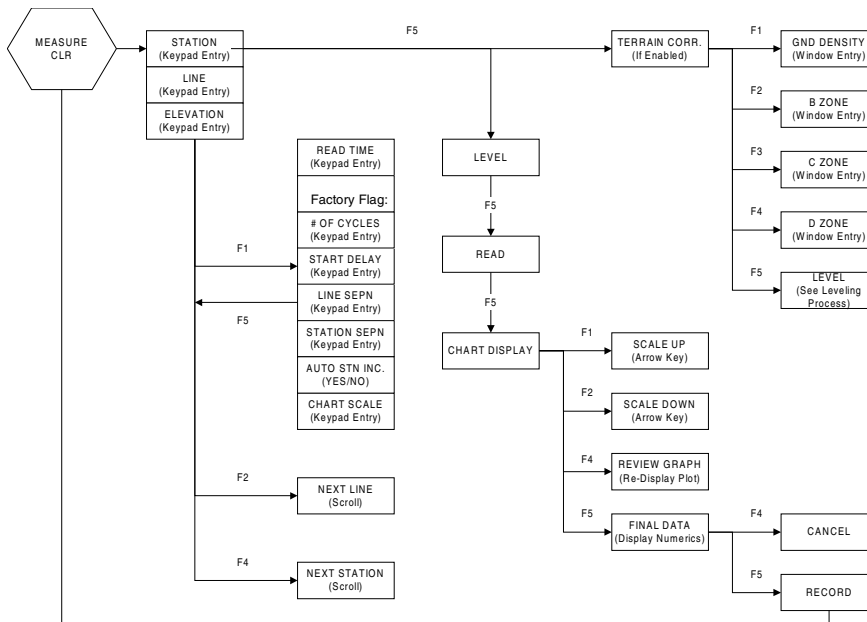

Tilt Sensitivity Corrections

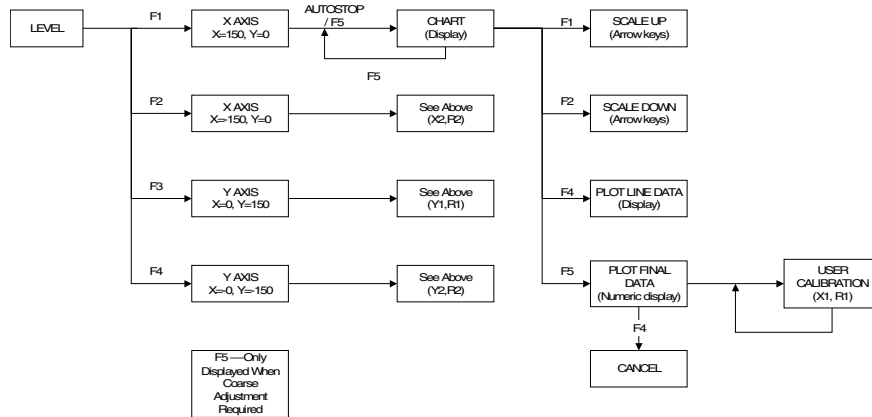

Menu Maps

Other Menu Maps

Recall Menu

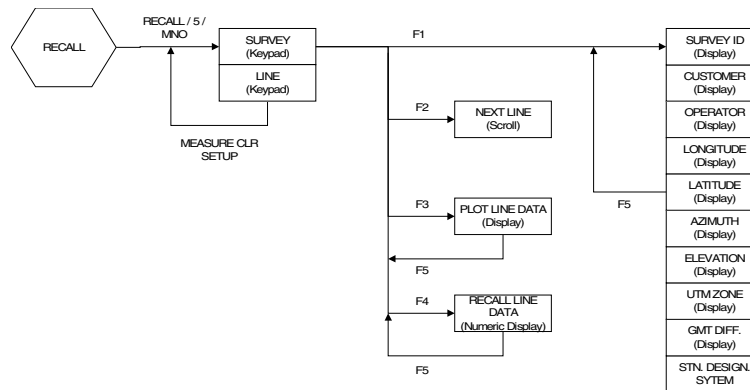

Display Menu

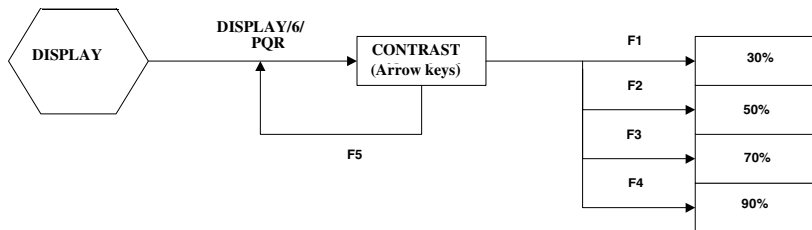

Info Menu

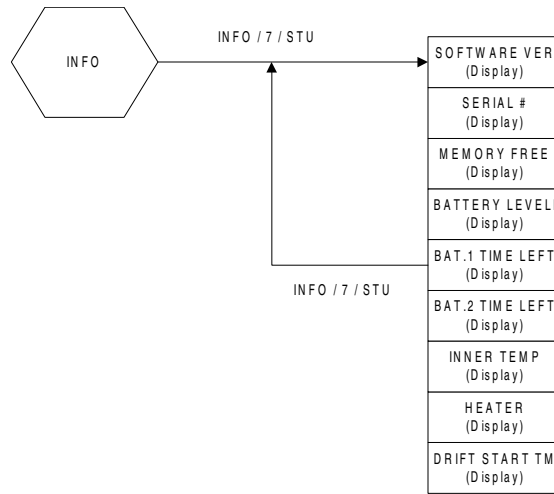

Menu Maps

Note Menu

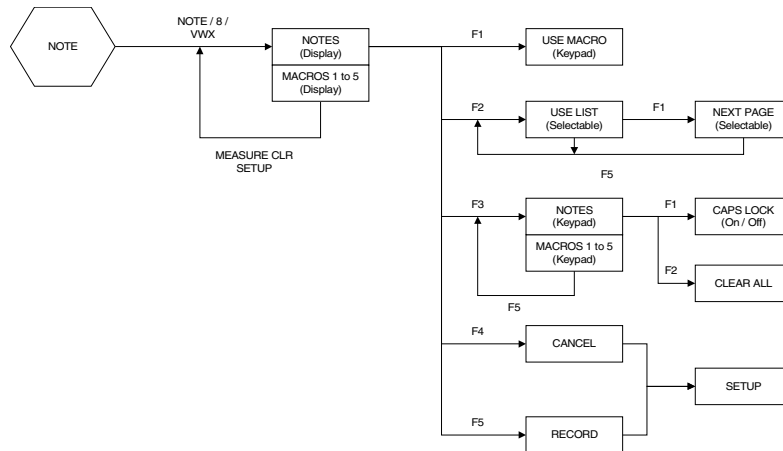



Index

Numerics

1/ABC Key 1-16

2/DEF Key 1-16

3/GHI Key 1-16

9/YZ Key 1-16

A

Arrow keys 1-15

B

Base station

selecting 4-5

setting to base station mode 2-20

Battery

changing 5-5

charging

notes 5-7

checking 5-4

determining the amount of time left 5-1

life expectancy 5-4

low battery warning 5-4

operating guidelines 5-5

replacing with new ones 5-5

specifications 1-10

temperature effects 5-3

using SBDS compliant batteries 5-2

C

Calibrating the CG-5

GCAL1 calibration constant 5-32

Calibration 2-34

Calibration factors B-9

CG-5

data, numeric 1-34

data, profile 1-33

detailed system overview B-4

determining battery time left 5-1

display 1-19

displayed reading 6-1

entering and editing information 1-23

estimating remaining service life B-7

instrument parameters 2-14

main measurement screen 1-19

minimizing noise

motion 4-3

wind 4-4

operating

before stabilization is complete 4-5

for first time 1-8

in cold weather 4-5

remotely A-1 to A-23

overview of keys 1-15

Powering up the CG-5 1-8

reading process B-4

reading range B-6

re-calibrating main calibration constant 5-32

re-calibrating, deriving new GCAL1 5-33

resetting 1-12

setting up 2-1

smart battery technology 5-1

specifications

- general 6-2
 - hardware 6-3
 - software 6-4, 6-6
- stabilization period 1-8
- station designation systems 2-8
- storing 5-34
- survey parameters 2-11
- system overview B-1
- transporting tips 4-2
- turning on 1-18
- Chapter layout scheme 1-3
- Charger
 - operating 1-11
- Clock
 - adjusting the 2-22
- Cold Boot 1-11
- Console
 - overview 1-14
 - reading process B-4
- Contrast
 - adjusting 1-18
- Corrections
 - calibration factor 2-16, B-9
 - continuous tilt 3-2
 - drift 2-17, B-16
 - gravity offset 2-16, B-21
 - temperature 2-16
 - temperature compensation B-19
 - terrain 3-2, 3-12 to 3-15
 - tide 3-2, B-20
 - tide correction 2-13
 - tilt B-17
 - tilt offset 2-16
 - tilt sensitivity 2-16
 - user calibration 2-34

D

Data

- canceling a reading 3-20, 3-23
- continuous readings 2-18
- Converting *raw to *.sgd 3-51
- displayed reading 6-1
- downloading with SCTUTIL program D-1
- dumping 1-36, 2-25, 3-38 to 3-51
- formats
 - log 3-40
 - raw 3-40
 - SGD 3-40
 - smp 3-40
 - txt 3-40
 - xyz 3-40
- line data
 - plotting 3-36
 - recalling 3-37
- reading 3-17, 3-21
- recalling 3-33 to 3-37
- recording 3-20, 3-23
- recording remotely A-18
- reviewing final data 3-19, 3-22
- single station readings 2-18
- variables stored during readings
 - B-5
- Direction/Sign Keys 1-17
- Display heater 1-19
- DISPLAY/6/PQR Key 1-16
- Drift correction
 - checking 1-31, 5-10
 - formula 5-14
 - overview B-16
 - residual 5-11
 - using

- manual method 5-13
- software method 5-11
- Dumping data 1-36, 2-25, 3-38 to 3-51
 - RS-232 mode 3-38 to 3-51
 - USB 3-52
 - USB mode 3-53 to 3-56

E

- East/+ Key 1-17
- Elastic hysteresis
 - definition C-1
- ENTER Key 1-15
- Entering values in fields 1-23 to 1-27
 - alphanumeric entry, example 1
 - 1-24 to 1-26
 - alphanumeric entry, example 2
 - 1-26 to 1-27
- ESC/0 Key 1-16
- Estimating remaining service life B-7

F

- F1 to F5 keys 1-15
- Factory tests 2-35
- Filters
 - seismic 3-2
- Flash memory 3-63
- Function keys
 - description 1-15
- Function/Alphanumeric Keys 1-16

G

- Gravity offset
 - overview B-21

H

- Help

- on-line 1-29
- HELP/Decimal Key 1-17

I

- INFO/7/STU Key 1-16

K

- Keyboard
 - description 1-15
- Keypad
 - overview 1-14
- Keys
 - 1/ABC 1-16
 - 2/DEF 1-16
 - 3/GHI 1-16
 - 9/YZ 1-16
 - Arrow 1-15
 - Direction/Sign 1-17
 - DISPLAY/6/PQR 1-16
 - East/+ 1-17
 - ENTER 1-15
 - ESC/0 1-16
 - F1 to F5 1-15
 - Function/Alphanumeric 1-16
 - HELP/Decimal 1-17
 - INFO/7/STU 1-16
 - MEASURE / CLR 1-15
 - North/+ 1-17
 - NOTE/8/VWX 1-16
 - ON / OFF 1-15
 - RECALL/5/MNO 1-16
 - SETUP/4/JKL 1-16
 - South/- 1-17
 - West/- 1-17

L

- Leveling
 - avoiding hysteresis effects C-2
 - remote operation A-17
- Levelling the CG-5 3-16
- Line separation 2-21

M

- Macros
 - defining 3-29 to 3-30
 - using 3-31 to 3-32
- Manual symbols 1-4
- MEASURE / CLR Key 1-15
- Memory
 - clearing the 3-63 to 3-64
 - Flash 3-63
- Menus
 - moving between 1-20 to 1-22

N

- North/+ Key 1-17
- NOTE/8/VWX Key 1-16
- Notes
 - entering 3-25 to 3-32
 - recording 3-25 to 3-32
 - manually entered notes 3-32
 - using available macros 3-29 to 3-32
 - using pre-defined list of features 3-26 to 3-28
- Numeric 1-34
- Numeric parameters
 - entering 1-15

O

- ON / OFF Key 1-15

On-line screens

- HELP 1-29
- system information 1-30

P

- Page numbering 1-1
- Parameter
 - # of Cycles 2-20
 - Altitude of grid reference point 2-7
 - Auto station increment 2-21
 - Azimuth of grid system 2-7
 - calibration factor 2-16
 - Cycle Time 2-20
 - Drift 2-17
 - Drift Start TM/DT 2-17
 - Easting 2-7, 3-9
 - GMT difference 2-7
 - Gref 2-16
 - Line separation 2-21
 - Longitude 3-7
 - Northing 2-7
 - Numeric parameters
 - entering 1-15
 - Optional parameters
 - grid reference point 2-7
 - header 2-6
 - Read Time 2-20
 - Start Delay 2-21
 - Station separation 2-21
 - Survey 2-4 to 2-6, 2-12 to 2-14
 - Temperature correction 2-16
 - Tide correction 2-13
 - TiltX Offset 2-16
 - TiltX Sensitivity 2-16
 - TiltY Offset 2-16
 - TiltY sensitivity 2-16

UTM Zone 2-7

R

RECALL/5/MNO Key 1-16

Recalling data 3-33 to 3-37

Remote operation A-1 to A-23

 configuring Autograv settings
 A-12

 configuring options A-14

 configuring survey settings A-11

 disconnecting A-23

 dumping data A-21

 erasing memory A-22

 generating output A-19

 installing software A-4

 leveling A-17

 recording data A-18

 setting the clock A-16

 starting and linking A-10

Reprogramming your CG-5 3-57 to
3-62

Resetting the CG-5 1-12

S

Scintrex offices

 addresses 2-32 to 2-34

Screens

 Clock 2-22 to 2-24

 Memory 2-28 to 2-30

 Options 2-18 to 2-22

 Service 2-31 to 2-35

 Setup 2-2, 3-60, 5-18, A-2

 Survey 2-3 to 2-10

SCTUTIL program

 installing D-2 to D-8

 installing USB driver D-9 to D-26

 minimum system requirements
 3-52

 running D-8

Seismic filter

 advantages of using B-15

 description B-11

Sensor

 design B-2

SETUP/4/JKL Key 1-16

Shipping instructions 5-47 to ??

Smart battery

 capabilities 5-1

Software

 CG5REMOTE A-4

 data processing 6-8

 installing USB driver D-9 to D-26

 SCTUTIL

 installing D-2 to D-8

 SCTUTIL, minimum requirements
 3-52

 upgrading your software version
 2-34, 3-57 to 3-62

South/- Key 1-17

Standard deviation

 calculation B-10

Station Designation System

 formats 2-8

 LAT/LONG stations and lines 3-7

 NSEW stations and lines 3-5

 setting up 3-3

 UTM stations and lines 3-8

 XY stations and lines 3-4

Station separation 2-21

Surveys

 scrolling through 3-34

T

- Temperature compensation
 - overview B-19
- Terrain corrections 3-12 to 3-15
- Text
 - entering and editing 1-23
 - UPPER CASE and lower case 1-27
- Tide correction
 - overview B-20
- Tilt correction
 - adjusting sensor offsets 5-17
 - checking 5-17
 - definition 5-17
 - overview B-17
 - performing fine XE adjustment 5-17
 - performing fine YE adjustment 5-24
- Tilt sensor correction
 - adjusting cross coupling 5-29
 - adjusting Y-axis sensitivity 5-28
 - adjusting X-axis sensitivity 5-25
- Tilt sensor cross-coupling correction
 - adjusting 5-30
 - definition 5-29
 - measuring 5-29
- Tilt sensors
 - description B-2
- Tripod 3-11
 - maintaining 5-34
 - setting up 3-10
- Trouble-shooting 5-35 to 5-36, 5-37 to 5-46
- Turning the CG-5 On 1-18
- Type styles scheme 1-2

U

- Upgrading
 - software version 2-34, 3-57 to 3-62
- USB
 - Dumping data 3-53 to 3-56
 - Important notice 3-52
 - installing USB driver D-9 to D-26
- USB port 5-37 to 5-46

W

- Warning
 - USB requirements 3-52
- Warranty and repair 5-46 to ??
- West/- Key 1-17

Head Office

222 Snidercroft Road
Concord, Ontario
Canada, L4K 1B5
tel: +1-905-669-2280
fax: +1-905-669-6403
service@scintrexltd.com

In the U.S.A.

Micro-g Lacoste
1401 Horizon Avenue
Lafayette, Colorado
80026
tel: +1-303-828-3499
fax: +1-303-828-3288
e-mail:info@microglacoste.com

SCINTREX

